



**DYNAMIC SCHOOL & LIBRARY FURNITURE
FOR MAXIMIZING STUDENT ENGAGEMENT**





Our furniture is manufactured by 400 employees in Germany, because short distances protect the environment.

MADE IN GERMANY
RAL
FSC
TÜVRheinland
level 3

Management System
 ISO 14001:2015
 ISO 9001:2015
 www.tuv.com
 ID 0910075053

Das Zeichen für verantwortungsvolle Waldwirtschaft

www.tuv.com
 ID 0000081288

A GOOD EXAMPLE OF EDUCATION.

The careful use of resources stands for our conviction that quality and sustainability belong together. As educational institution, we have a special responsibility in this respect: Our products will shape future generations.

This is precisely why we are committed to carefully treating nature and the environment by

- avoiding tropical woods
- not using substances containing solvents
- remaining significantly below the legal emission limits
- producing low-dust and low-sound
- reducing packaging
- efficiently disposing of waste

We would be delighted if this commitment is to be rewarded: Our products are repeatedly awarded numerous seals of approval and certificates. This motivates us every day anew to put safety and quality into practice. And to work on many new developments that we make transparent - through regular checks by independent experts and in our own laboratory. Because quality is the benchmark for us, today and tomorrow.



OUR MOST IMPORTANT TOOL: THE EAR.

When we at A2S develop a new product, the first thing we do is work with our ears. Our experience tells us: Our customers know exactly what requirements the ideal chair or table must meet. That is why we take the time to listen to them in peace. The result is furniture such as Flex, which enables flexible learning and can cope with the tough everyday school life. Flex is full of intelligent ideas: Its waisted backrest allows people to sit upside down from time

to time, so that the "owners" can stay healthy in motion. Also its floor protectors are not only gentle on the floor, but also on the nerves. Flex is just one of many examples to show: For designing and realisation of our chairs and tables we love to learn from our customers. Our field service advises you already during planning and conception of your rooms and can thus take all wishes and requirements into

account. In order to give you an idea of how living and working with our ideas will change, we present photorealistic drafts of your plans in advance. This is how rooms are created according to your ideas - with A2S as your competent partner.



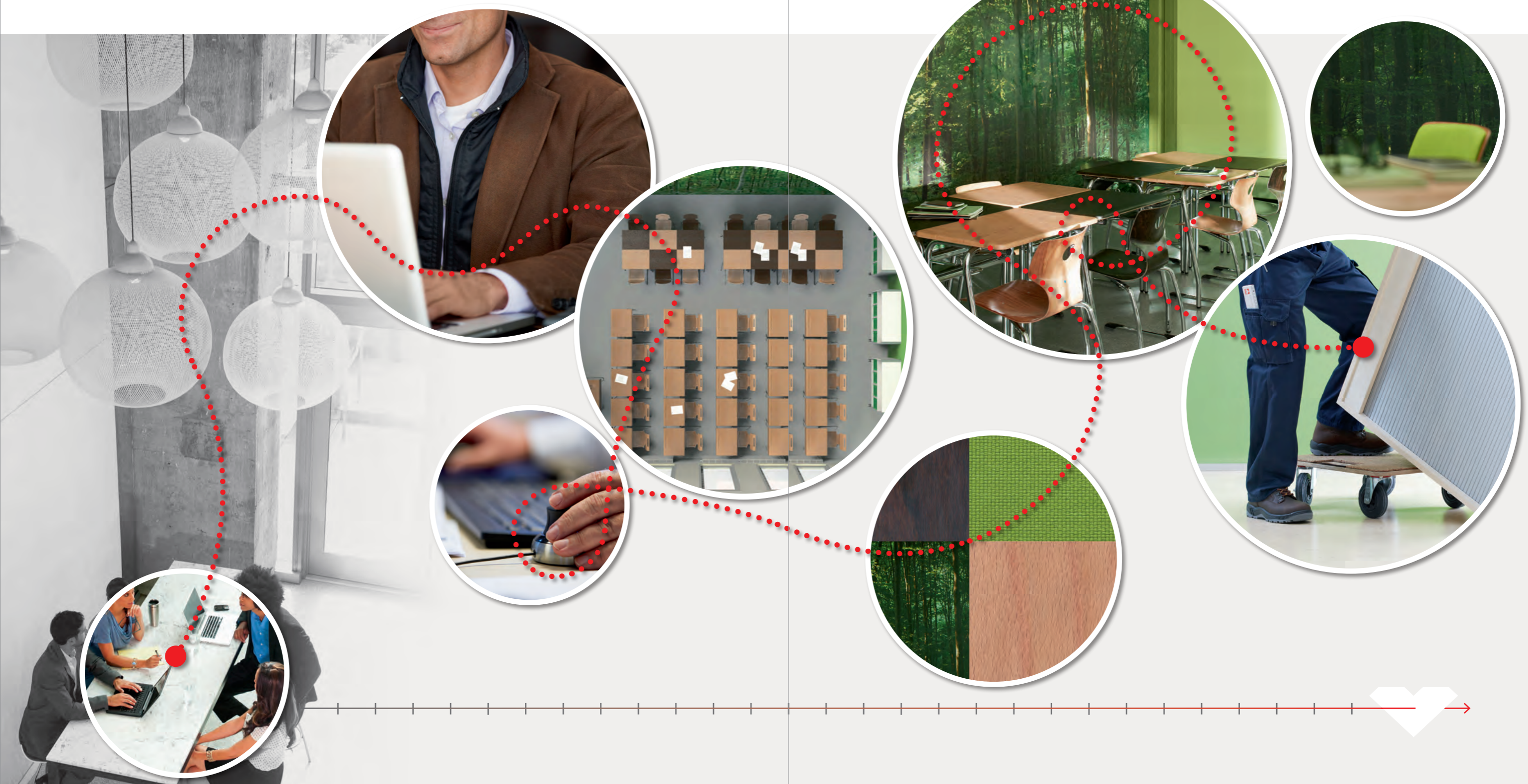

WE'RE HERE FOR YOU.

Our customer service department takes care of everything else, so that you can concentrate fully on your educational work. And that even before you buy anything from us:

Our sales representatives will be happy to inform and advise you on site and discuss all your wishes with you. The A2S planners set everything up according to your ideas and,

if desired, visualise the planned room photorealistically in advance. We deliver your furniture mostly pre-assembled, some larger pieces we assemble on site.

In the unlikely event that something does not meet your expectations or a spare part is required, we will resolve the issue, quickly and reliably - and that's a promise!

ELEMENTARY SCHOOL

The time spent learning in the elementary school years builds the foundation for a student's entire school career. It is the basis for a happy, responsible, and successful future. All children should be provided with an outstanding education, one that is tailored to their capabilities, in order to ensure a successful transition to secondary schools. Various teaching concepts can be supported with sophisticated, positively-designed learning environments.

Clearly-arranged and flexible furnishing concepts make varied daily routines easier. In addition to the traditional teaching phases, space is created for movement, as well as group and individual work. This promotes the cognitive, social, emotional, and physical aspects in children.



Single-function use | Instruction/Resting area | Fixed furniture | Height-adjustable

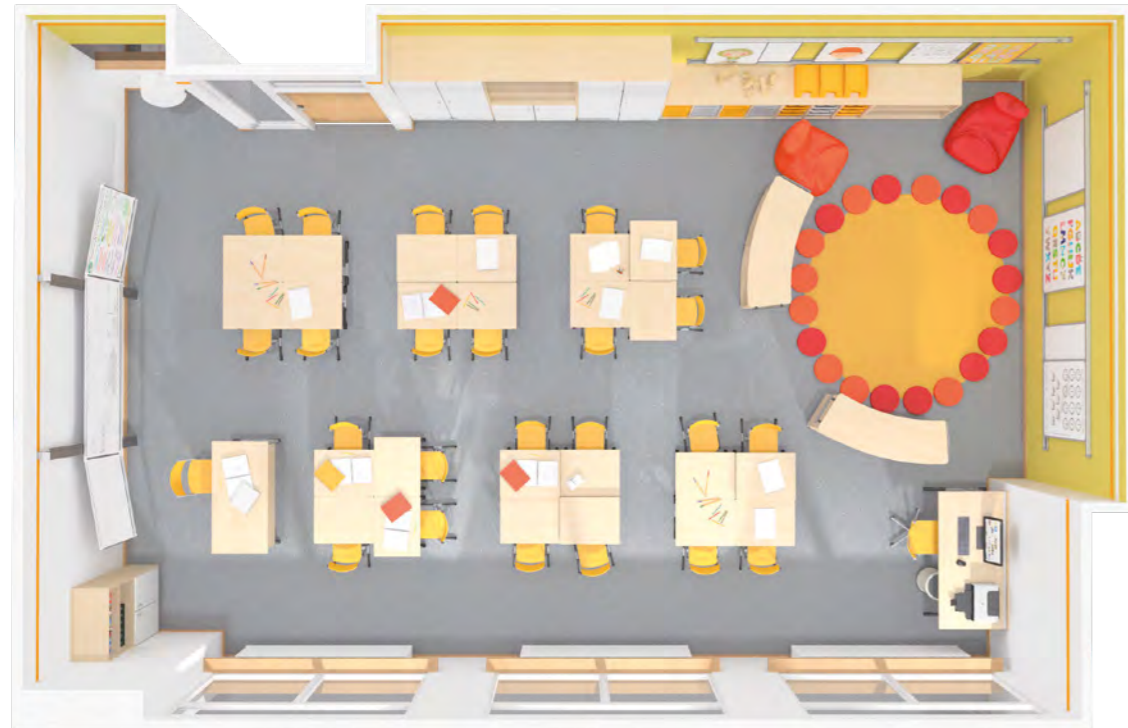

PRODUCTS

STUDENTS

- 7130 School chair
- 7750 School table

TEACHERS

- 8382 WOODPLAC®
pneumatic spring swivel chair
- 7523.901 Teacher's desk C-shape

MORNING CIRCLE / RESTING AREA

- 4425.150 Segmental arched shelf
- 5030.035 CHILL bean bag Junior
- 5034.001 Seat cushion

PC WORKPLACE

- 1810.168 Computer table
- 8382 WOODPLAC®
pneumatic spring swivel chair
- 7894 Pneumatic lift stool



The height-adjustable individual tables can be easily adapted to fit each student, enabling pleasant, ergonomically correct learning.

Mono-functional use | Instruction/Seating circle | Fixed furniture | Fixed size

GROUP WORK
A SET SPOT IN THE GROUP.

For children, school enrollment means entering a completely new environment. Small groups and set spots provide advantages, so children can focus on learning from day one.

Using the example to the left, height-adjustable tables ensure that students of different sizes can work together in an ergonomically pleasant way. An area separated by mobile, segmented arched shelves with seat cushions, can be used for a seating circle, or as a break-time retreat.

Using the example to the right, the compact arrangement of the traditional solid wood desks offers ample room for an additional seating area with benches.



PRODUCTS

STUDENTS

- Solid wood chair 7000
- Solid wood desk 7030

TEACHERS

- Solid wood chair ISO6 7000
- Teacher's desk 7057.901

MORNING CIRCLE/SEATING CIRCLE

- Solid wood bench 9459.004



Our 70-series: The traditional combination of solid wood chair and desk creates a warm, natural learning atmosphere.



Multi-functional use | Instruction/seating circle | Flexible furniture | Learning at eye-level

DIFFERENTIATED LEARNING ALWAYS RETHINK THINGS.

Frontal instruction, working in silence or in groups, seating circle - depending on the phase of instruction, the division of the learning room can be rearranged several times a day. In order to meet the needs of students and teachers, the seating arrangement must be able to be changed quickly and easily. With little effort, the flexible individual desks with casters can be moved, and the chairs with footrests bring all students to eye level at a single movement..

PRODUCTS

STUDENTS

- 7416.031 Chair with footrest PAGHOLZ®
- 7280 School table with casters

TEACHERS

- 8385.002 PAGHOLZ® Pneumatic spring swivel chair
- 7940 Pneumatic lift stool
- 7615.138 Elliptical mono-column table, height-adjustable
- 4130.506 Teacher CHANGE caddy

PC WORKPLACE

- 2000-series Table system with CPU equipment



Working with a partner



Seating circle



U-shape



Group work



Frontal instruction



The chair with footrest brings students of different sizes to eye level at a table. The tables equipped with casters, depending on the need, allow for the seating arrangement to be changed quickly and easily.



The chair with footrest brings students of different sizes to eye level at a table. The footrest can easily and safely be set to the right height in one quick movement.



Big group



Small groups



Individual work

PRODUCTS

STUDENTS

7416.031 Chair with footrest PAGHOLZ®

7280 School table with casters

TEACHERS

7940 Pneumatic lift stool

RESTING AREA

5005.001 Folding couch

6710.090 COMBi acoustic partition wall

5030.035 CHILL bean bag Junior

5032.035 CHILL stool Junior



DIFFERENTIATED SPACE
SCHOOL FOR ALL CHILDREN.

The associated differentiated space for customizing learning meets the demand by offering a stimulating place of learning for all children. It can be used to provide individual support, as an area of retreat, to concentrate on the lessons and materials, or for undisturbed conversations - for example with parents.



Our product range of bean bags and floor cushions provides the necessary balance of comfort - because it is well-known that relaxed students learn the best.





Frontal instruction



U-shape

MUSIC ROOM A ROOM COMPOSITION FOR EVERY KEY.

Whether it's theoretical music lessons, or simply performing music ... even singing - the flexible furniture makes it easy to quickly change from the frontal setup, to the two-row seating arrangement in a U-shape with benches on the inside.

A special cabinet for instruments on the back side of the room provides custom, secure storage space for valuables.

PRODUCTS

STUDENTS

- 7853 FLEX Z-shape chair
- 1001.303 Rectangular table
- 9445.180 Bench with casters

TEACHERS

- 7873.002 FLEX
pneumatic spring swivel chair
- 7616.097 Barrel-shaped mono-column table,
height-adjustable

SPECIALIZED ROOM

- 4444.011 Cabinet for Orff instruments

The stackable benches with casters make it possible to quickly rearrange the seating. The special cabinet offers custom storage space and protection for instruments.

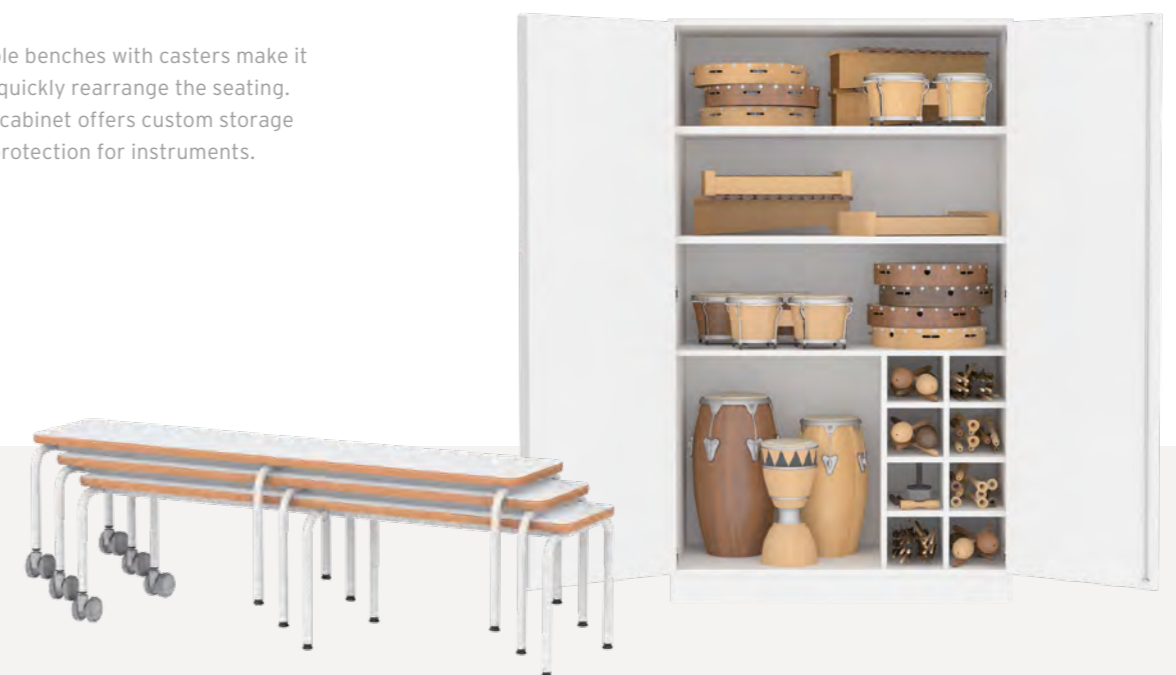



ART ROOM SPACE FOR ALL KINDS OF IDEAS.

The sturdy rectangular tables with stools are like a blank canvas that invites one to work, with a variety of materials, and with plenty of space. There is plenty of presentation space - with the sliding panel system on the cabinet wall and the picture clamping strip on the wall.

The drying trolleys and the space-saving storage of the drawing cabinets, transform the art room into an art studio.

PRODUCTS

STUDENTS

- 7984.017 Stool with step
- 1001.147 Rectangular table

TEACHERS

- 8386.002 PAGHOLZ® pneumatic spring swivel chair
- 7616.097 Barrel-shaped mono-column table, height-adjustable
- 8389 PAGHOLZ® pneumatic spring swivel stool
- 1001.147 Rectangular table with
- 2050.140 Screen

SPECIALIZED ROOM

- 1181.006 Drawings cabinet DIN A0
- 4193 Drying trolley

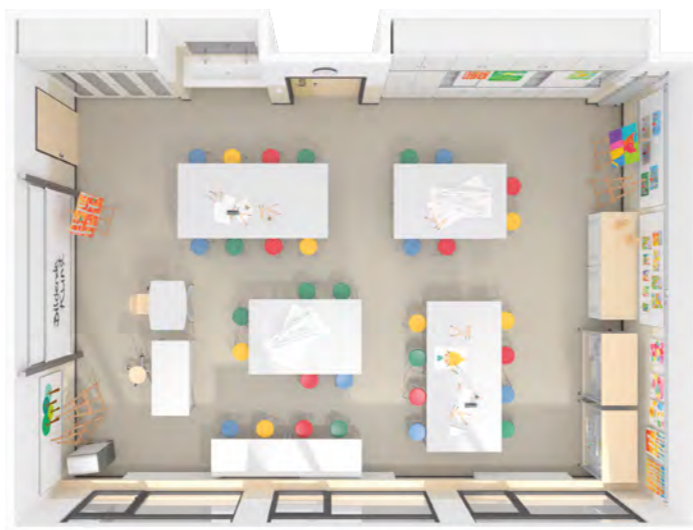

READING ROOM IN THE REALM OF READING ISLANDS.

Every child will find his or her reading island here - whether comfortably on a lounge cushion, a bean bag or completely concentrated at a table. The book cube invites children to exchange ideas and read together. Mobile bookcases zone the room into different quiet areas, or one could move the small library quickly into adjacent rooms.



PRODUCTS

TABLE GROUP

- PAGHOLZ® skid base chair 7307
- Semicircular S-shape 1019.147

ZONING

- Book trolley 6432.003
- Book cube 4009.001
- 90° shelf cabinet, rounded 4801.921
- Shelf cabinet 4490.500

LEARNING ROOMS

Learning is an individual process which works best when students have the ability to coauthor their own learning progress independently. Individual learning formats are becoming more popular. And they create ever-changing challenges for pedagogues and learning rooms alike: pedagogues are supposed to make it possible for every student to work in peace in their own way without losing sight of the overall picture; learning rooms should generally have both multi-functional equipment and specialized areas.

When designing learning rooms, A2S focuses especially on zoning and acoustics. This is to ensure that classical lecture format, group work, partner work, but also silent work, retreat, and relaxation are possible in one and the same environment.



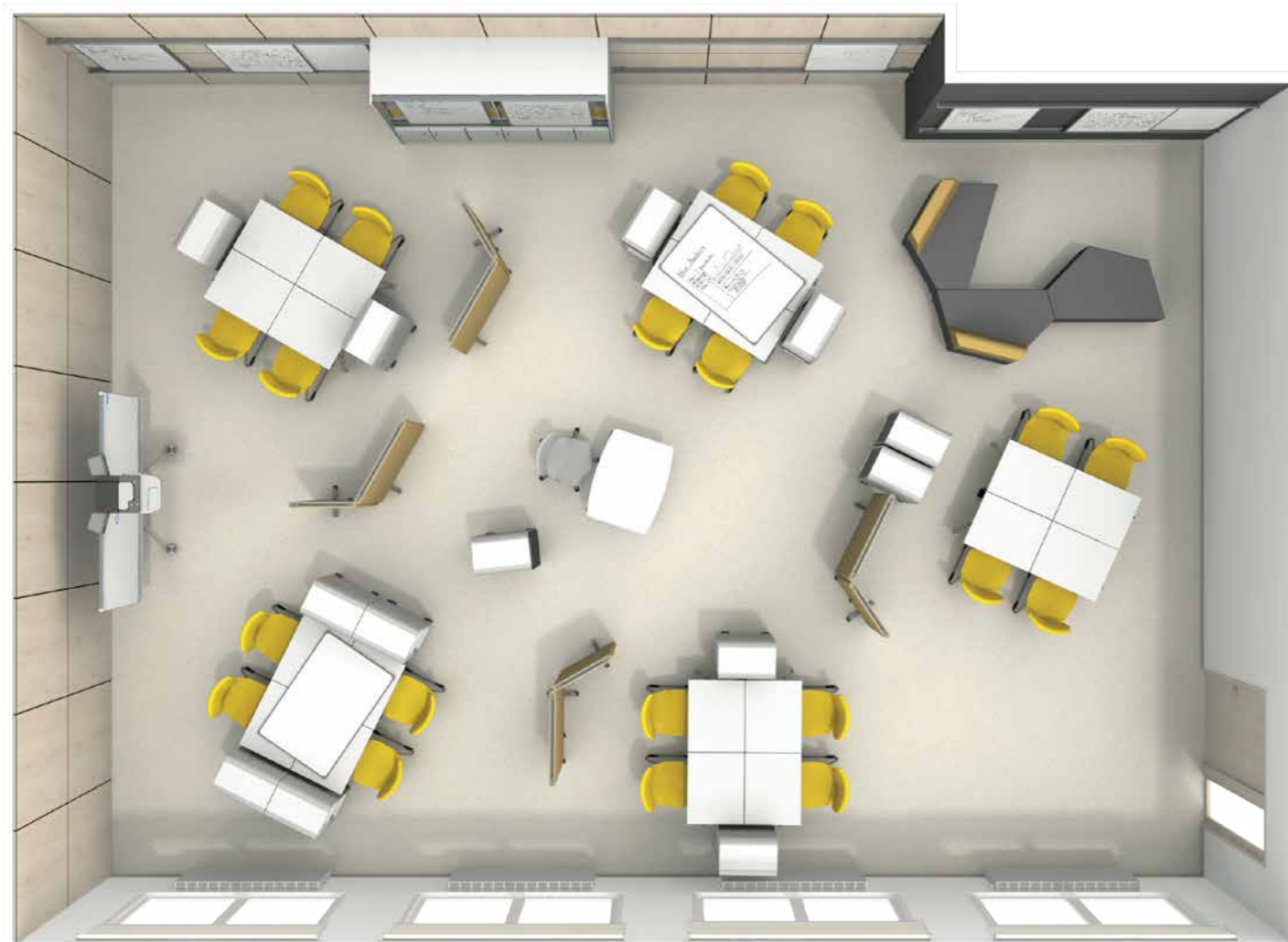

Group work

MULTI-FUNCTION ROOM

YOU DON'T NEED A LOT OF SPACE, JUST GOOD IDEAS.

This room concept allows for all social forms: classic lecture format, group or partner work, and silent work. You can also create secluded retreat and relaxation areas. The flexible furniture has versatile uses for self-directed and competence-oriented learning. Acoustic barriers create a disturbance-free work atmosphere, especially for intensive individual work. The height allows you to keep an eye on everything even when you are behind the barriers.

The student caddies, individual or as partner caddies, give each student the possibility of storing his/her personal learning materials in the classroom. If needed, the individual student and teacher caddies can easily be combined into a practical, expandable material cart.

In order to underline the idea of mobility and ensure flexibility for all constellations, all walls were given robust, flexible wall board systems. The surfaces are either whiteboard or chalkboard.



Individual work



Partner work



Classic lecture format



The textile-covered, movable acoustic barriers permit the free, discrete zoning of the room. Their height allows you to keep an eye on everything at all times. The personal caddies for students and teachers follow you to every work station and can be linked into entire shelf units if needed.



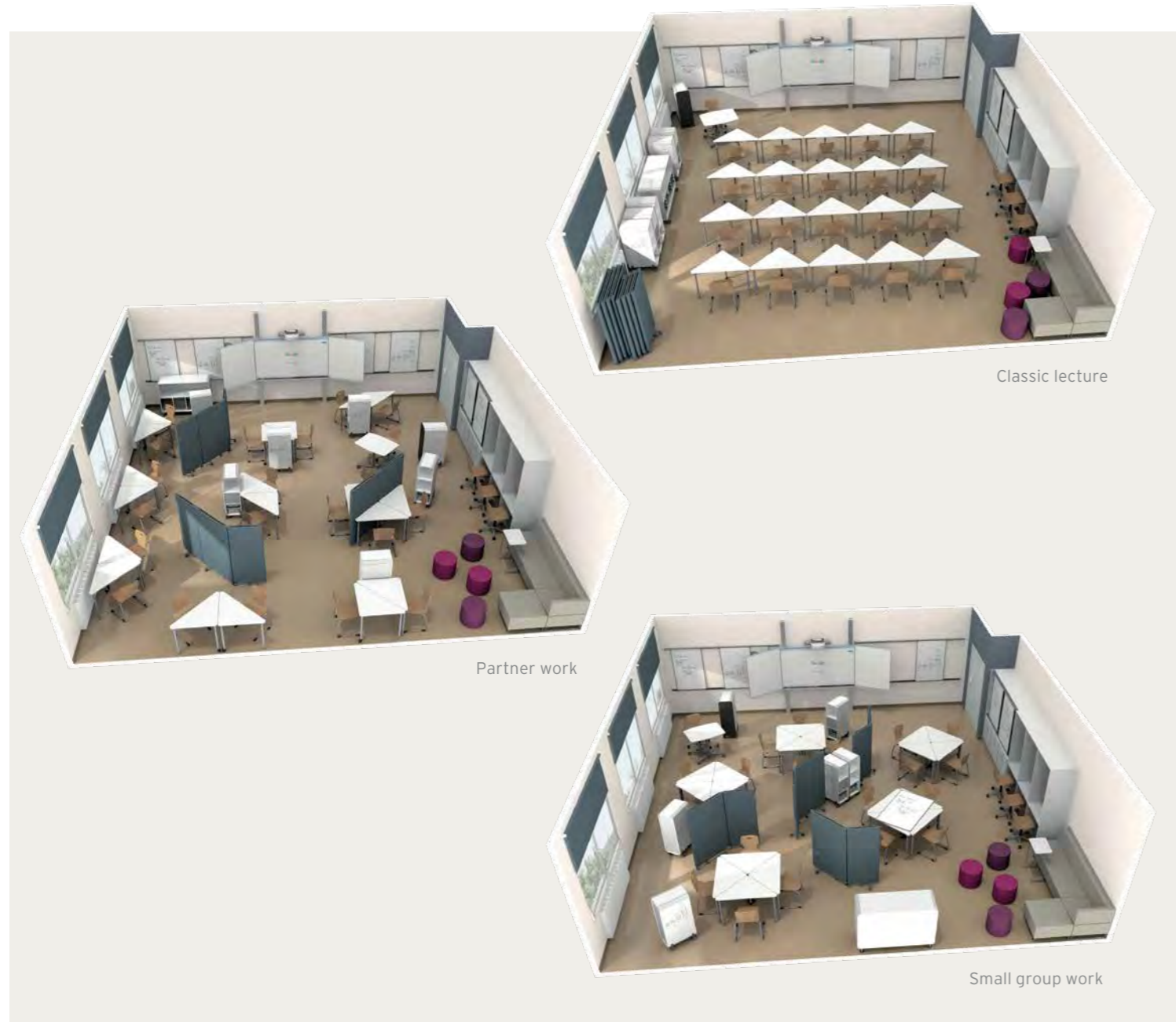

Classic lecture

Partner work

Small group work

MULTIFUNCTION ROOM WITH TRIANGULAR TABLES
**FLEXIBLE FURNITURE ALSO
 CREATES AN ACTIVE MIND.**

Whether classic lecture format, group or partner work - the triangular tables adapt to every instruction style because they can be rearranged quickly and easily into every possible constellation for 2 to 8 students..

In addition to the flexible triangular tables, protected IT work stations provide peace and quiet for focused internet research. The combination of caddies and acoustic barriers gives teachers the freedom to divide the room into zones for differentiated work without restricting their ability to keep an overview. A retreat and relaxation area offers space for small breaks.



Group work

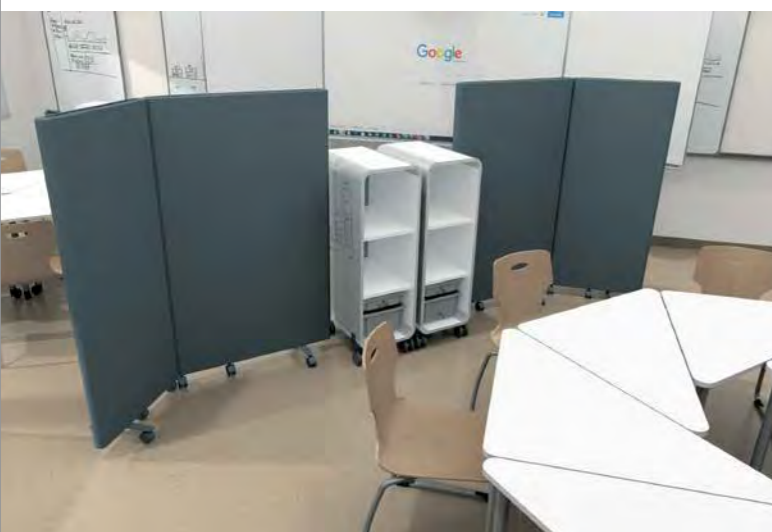

The triangular tables, easy to move and combine, are combined with chairs with light Pagholz® seats and C-shaped frame. The double-sided caddies can be accessed by two students at the same time.





Group work

MULTI-FUNCTION ROOM WITH WAVE-SHAPED TABLES
SMALL CHANGES MAKE ALL THE DIFFERENCE.

This installation variant of the previous learning room shows that merely changing details like adding organic wave edges to the tables or altering the colours of the acoustic barriers and lounge furniture can result in a completely different room atmosphere.

In addition to the flexible work places at the freely combinable wave-shaped tables, there are also fixed IT work stations. Using material caddies and acoustic barriers, it is easy to quickly divide the room into zones for differentiated work.



Classic lecture



Silent/partner work

The eight-adjustable, single column table with a visual barrier ensures the greatest possible mobility for pedagogues. The ergonomically shaped Flex-Z provides students with maximum mobility.



COLOUR SCHEME

AGE GROUPS, ORDERED BY COLOUR.

In this model of multi-age-group learning, different learning groups are instructed by two pedagogues in one room based on proficiency levels. The colour coding based on proficiency level helps both students and teachers to orient themselves.

Flexible shelves and acoustic barriers allow for the quick and quiet creation of different zones in the room, depending on group size and instruction method. The mobile teacher work places can be pushed into the right position at any time. The pre-installed separation wall system provides the additional possibility of splitting the room into two separate classrooms if needed.

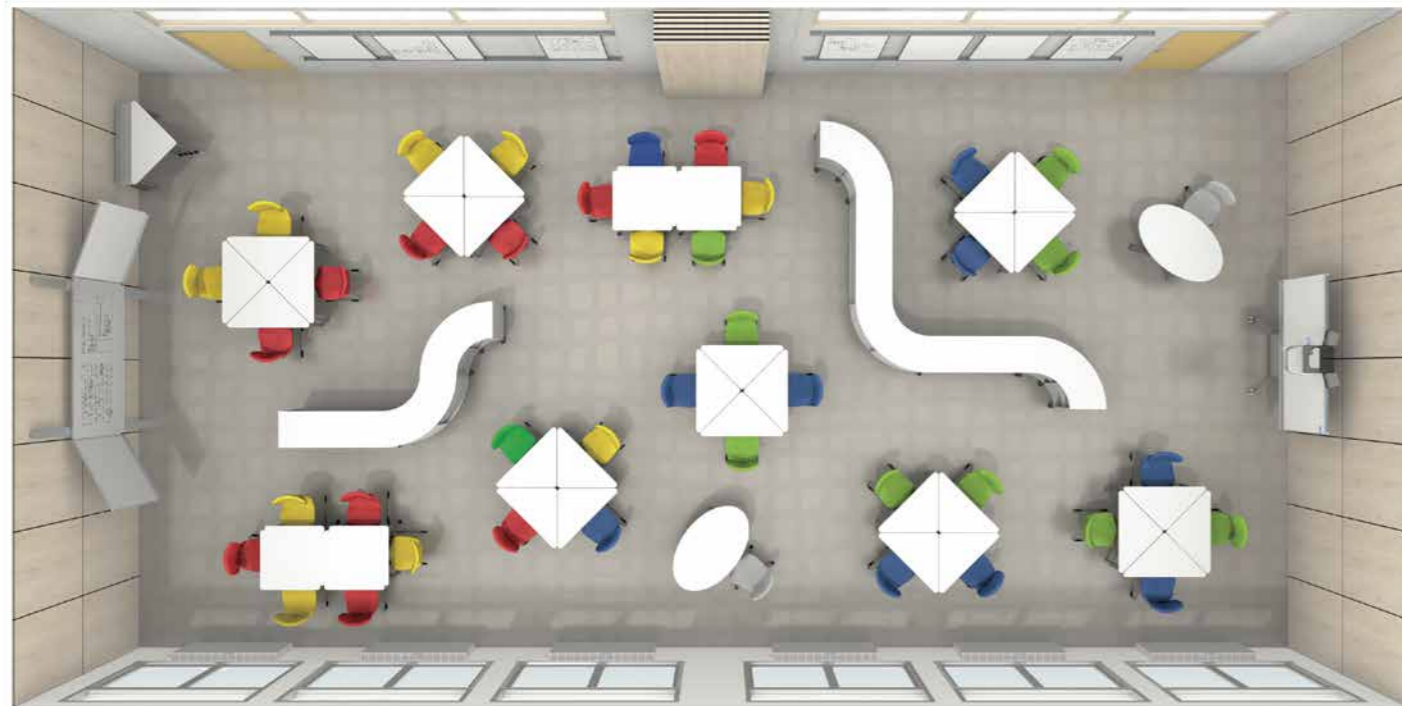

Group instruction



Flexible quarter circle shelves help structure the room. The footrest stool with simple and tool-free single-handed operation is suited for students of various body sizes.

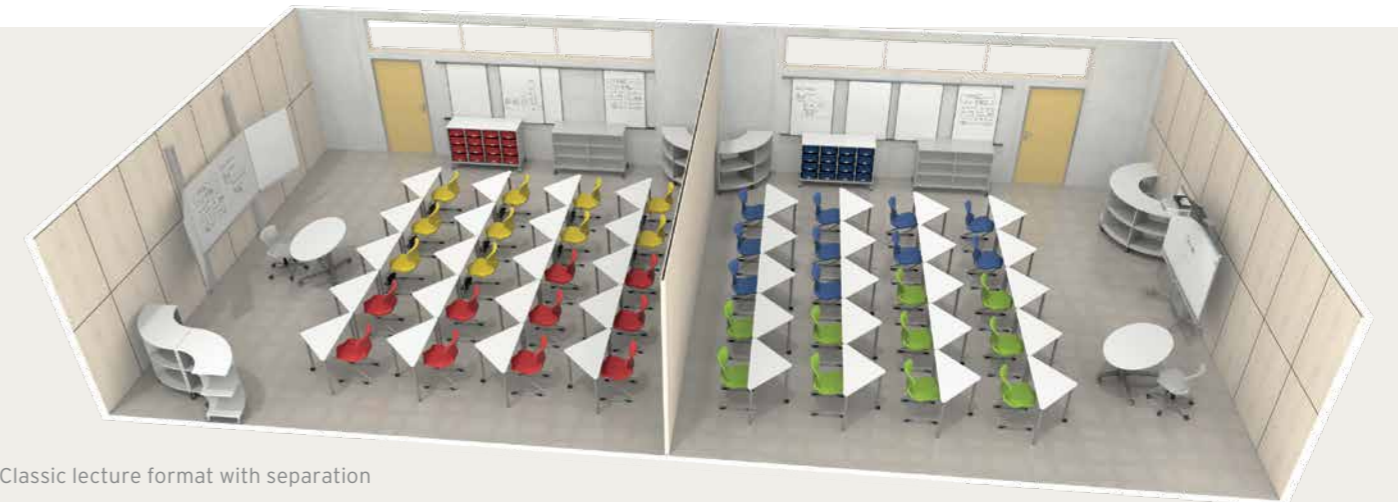

Classic lecture format with separation



Group work



Partner work with separation



Circle seating



Partner work

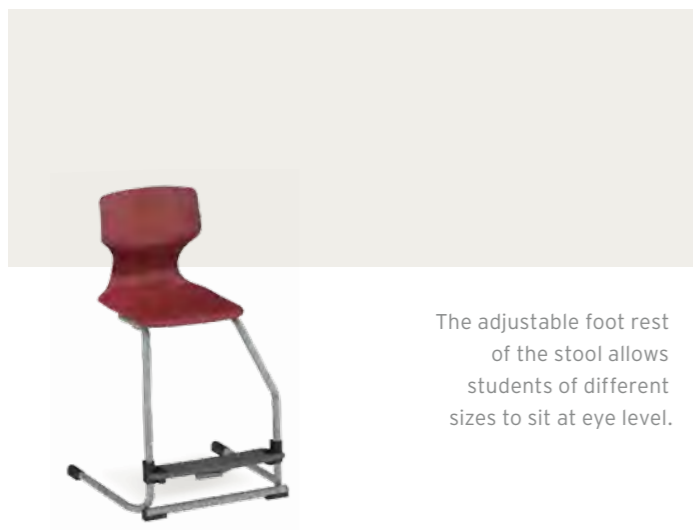

The adjustable foot rest of the stool allows students of different sizes to sit at eye level.



MULTI-AGE-GROUP LEARNING

ONE ROOM CONCEPT FOR ALL AGE GROUPS.

Current brain and development research confirms that the intellectual, psychological, and physical development of children do not run parallel. Even at age 7 there can be clear differences. Elementary schools thus not only combine children with different social origins, nationalities, and religions but also with very unequal developmental speeds and other learning-related preconditions, children with and without disabilities. An elementary school that claims to be a "school for everyone" must therefore develop learning and organization forms that consider this diversity an opportunity. Multi-age-group learning (IYL) provides a good possibility to do just that.

Using the mobile furniture, the learning room shown here can be easily adjusted for all needs and work forms. Chairs with easily adjustable foot rests allow students of different sizes to sit comfortably, ergonomically, and securely at a uniform height, which helps them keep a better overview of the room. The triangular tables can be configured in numerous arrangements and group constellations. The adjoining specialized room can be used for the more focused study of learning materials or for undisturbed meetings, for example with parents.



specialized room



Group instruction with specialized areas



Self-learning centre

Team room

THE CLUSTER MODEL

EVERYTHING AND EVERYONE UNDER ONE ROOF.

This building section houses several age groups in classrooms and group or specialized areas. The heart of such a cluster is an area that serves both as a learning and lounge zone in the centre of each floor. Team rooms, sanitary and storage possibilities are well integrated.

The flexible furnishings and the universally usable rail panel system provide every individual classroom with the possibility of flexible instruction in the various social forms. The additional large specialized area permits students of several classes to work individually at the same time.

A team room on every floor serves as a retreat for the pedagogues in order to work with focus or to recharge.

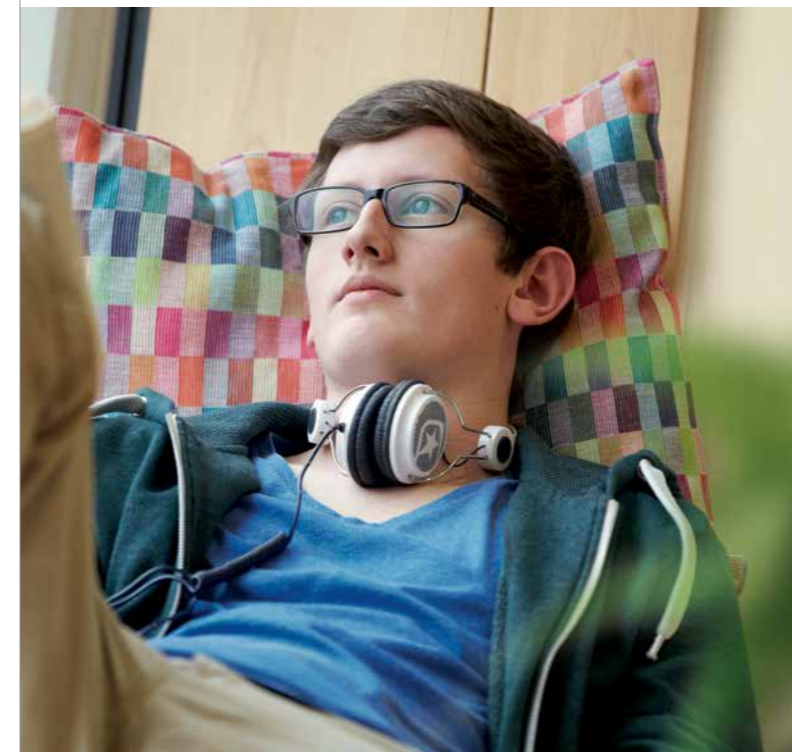

The modular media work stations are equipped with outlets and network plugs. The acoustic back walls can also be used as bulletin boards.





Lounge area



The cabinet system offers many different modules and surfaces for the individual design of hallway areas.



Wardrobe



LEARNING WITH FRIENDS.

Learning does not work without friends. A prerequisite to this is a philanthropic attitude that encourages friends to learn together.

HOW DOES LEARNING WORK?

The brain is not a muscle. We can practice and train it as much as we want because we learn by building relationships - with objects and people. Every time we discover something which is important for us, it "gets under our skin" and so-called emotional centers are activated in our brains. They lie in the center of the brain and are connected to all other areas.

WHAT EFFECTS DO FEELINGS HAVE ON LEARNING?

If the emotional centers are stimulated, chaos ensues in the areas that are responsible for regulating the body. This then expresses itself in feelings: The heart begins to race, we break into a sweat, it becomes hard to catch our breath, or we become weak in the knees. These are the somatic markers that occur when something "gets under our skin". And when we find a solution, this chaos becomes order again. This releases neuroplastic neurotransmitters which act like "fertilizer" and stabilize all the networks in the brain that contribute to the solution of the problem. For this reason, we can only learn something permanently when it is emotionally charged, i.e. is fun. Only when the emotional centers are stimulated - for instance when we manage to do something well or we have a "lightbulb moment" - are all the neurotransmitters released that result in plastic remodeling processes in the brain.

SO WHAT SHOULD BE DONE?

We should develop a culture of interaction with each other in which we do not put each other down or treat each other like objects but meet each other as subjects. We can do this by inviting, encouraging, and inspiring others to want to create another even better experience. There are people who not only manage to encourage other people but even inspire them because they enjoy igniting a spark in others. They reawaken the desire in others to open up again, to start something new, to open their eyes. And the wonderful thing about it is that somehow this always seems to work.

„ALL PEOPLE START THEIR LIVES AS DISCOVERERS AND DESIGNERS. THEY SHOULD NOT END UP AS OBJECTS IN THE EDUCATION AND TEACHING METHODS OF OTHERS.“

(Dr. rer. nat. Dr. med. habil. Gerald Hüther, Neurobiologist, Chairman of the Academy for Potential Development)

THE DYNAMIC CLASSROOM
**FOR BLENDED TEACHING AND
 STUDENTCENTRED LEARNING**



PRODUCTS

- 1 1007.001 Penta desk
- 2 4750.601 Media workstation
- 3 1014.165 Cloud table in standing height
- 4 7853 FLEX Z
- 5 7873.002 Gaslift chair with foot ring
- 6 7940 Stool
- 7 7620.138 Oval mono-column table
- 8 9124 CHANGE caddy
- 9 4130.502 CHANGE sideboard
- 10 Multifunctional cabinet combination with sliding board system
- 11 Sliding board system wall-mounted
- 12 5030.045 Beanbag



SELF-LEARNING CENTRE

In addition to specialized and multi-function rooms, self-learning centers provide the ideal supplement for self-directed deeper study of the material. Here, students can retreat into a relaxed, homey atmosphere or work together in teams. Different zones for research, communication, or work are characteristic. Libraries and media centers are generally part of a self-learning centre for secondary levels I and II. Communication and rest areas should be acoustically separated from each other, without the room losing its clear structure. In this way, one or two teachers are enough to monitor the class room. Due to the size of most self-learning centers, they can even be used for smaller events.



ROOM IN THE ROOM

**RIGHT IN THE MIDDLE OF IT
AND YET UNDISTURBED.**

The extraordinary thing about this room is the large rotunda-like structure, the outside of which acts as a library and offers both shelf space and individual work places. Its interior is acoustically shielded and offers the students a protected retreat for reading and relaxing. Due to its size, the inside area can also be used for presentations and discussions of entire learning groups.

Grouped around it are places for various work forms from individual and group work to internet research. The individual work places have lower acoustic separators which facilitate focused work free of interruptions.

Communication islands with flexible sitting elements and mobile book carts invite interactions in small or large groups. Despite the various possibilities, it is easy to have a full overview of the entire room due to its clear organization and zoning.

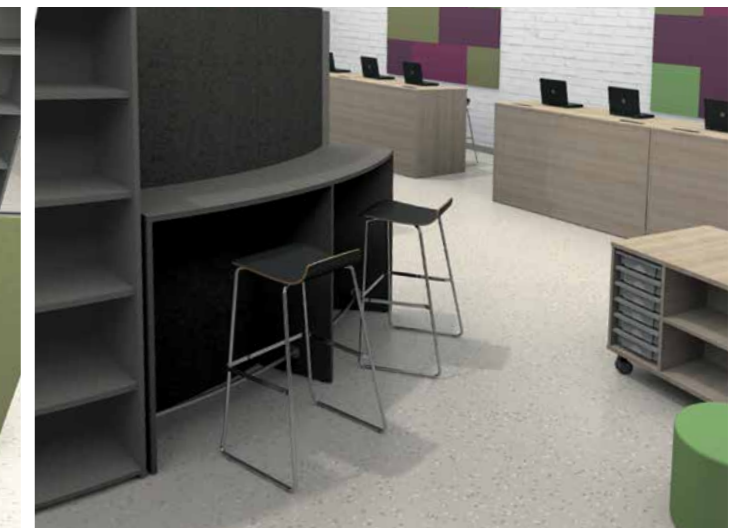
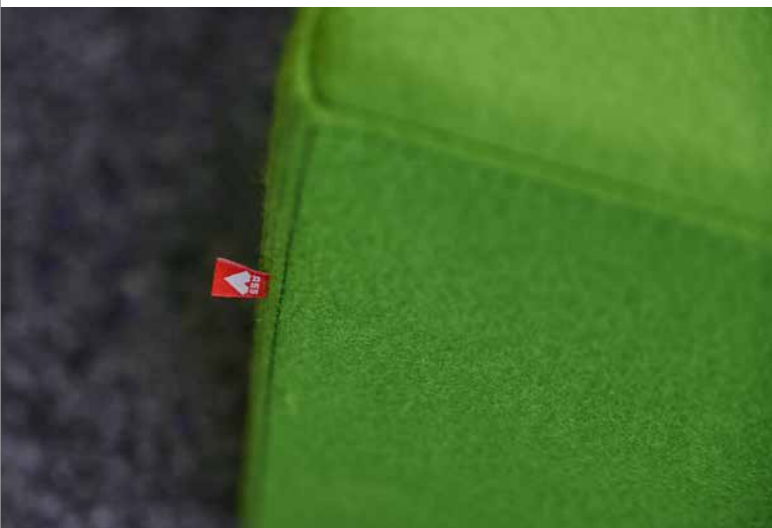
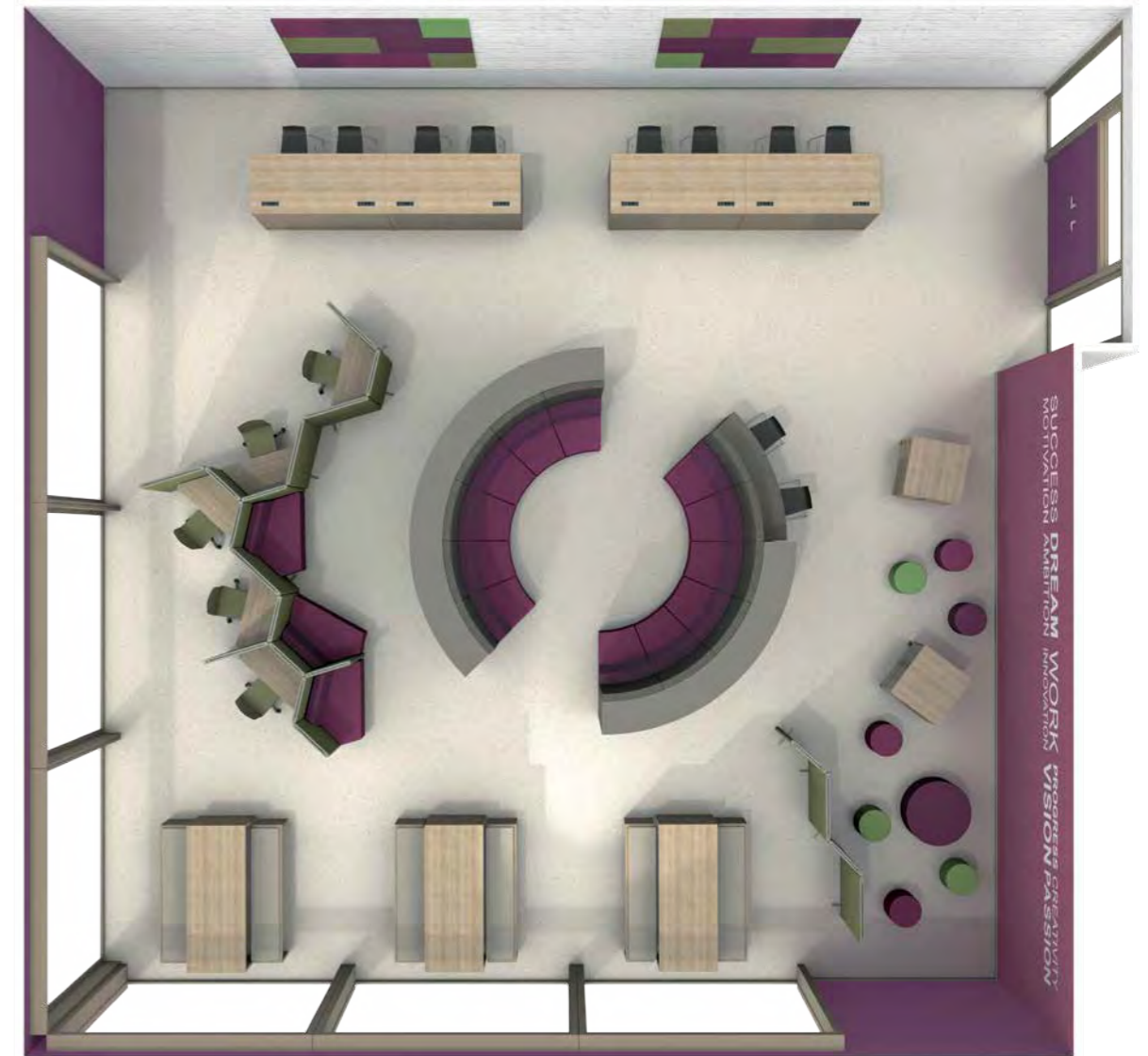

ATRIUM

A GOOD LEARNING CLIMATE BEGINS WITH THE RIGHT ENVIRONMENT.

There are various theories of how people can acquire and absorb new knowledge successfully. All of them have one thing in common: people like to learn and meet where they feel at home.

This self-learning centre in the atrium is used as a zone for meeting, communicating, learning, and relaxing.

Between the library and the various areas for large and small groups, there is a central rest area with comfortable sofa islands.

The high, sound-absorbing backrests invite students not only to relax but also to interact with each other. They do not disrupt the surroundings and are neither disrupting in and of themselves.



Panel end desks provide space for spontaneous meetings of large or small groups. Media work places with integrated electric and network outlets permit uncomplicated fast internet research.





The elements of the flexible wall board system can be shifted, turned, or taken out and be used in a flat orientation for joint work.



LEARNING LANDSCAPE A LEARNING UNIVERSE WITH A CALM CENTRE.

All around the rotunda-like acoustically shielded rest area, the library shelves are arranged in a star-shape. You can also find social areas around it: IT work stations, communication zones, retreat areas, and group work places.

An interesting thing about this variant are the three separate in-depth study rooms which can be used for group and specialized work as well as for meetings of the pedagogues or with parents.

REMODELING

ONLY ONE STEP TO THE SELF-LEARNING CENTRE.

This former specialized classroom was converted into a self-learning centre. The room, which is always used under supervision, contains a library and media centre, as well as several possibilities for group work and interaction. The second, adjoining room can be used for presentations and separate group discussions.

ROOM SIZE:
self-learning centre 13.0 m x 8.0 m
specialized room 8.0 m x 8.0 m

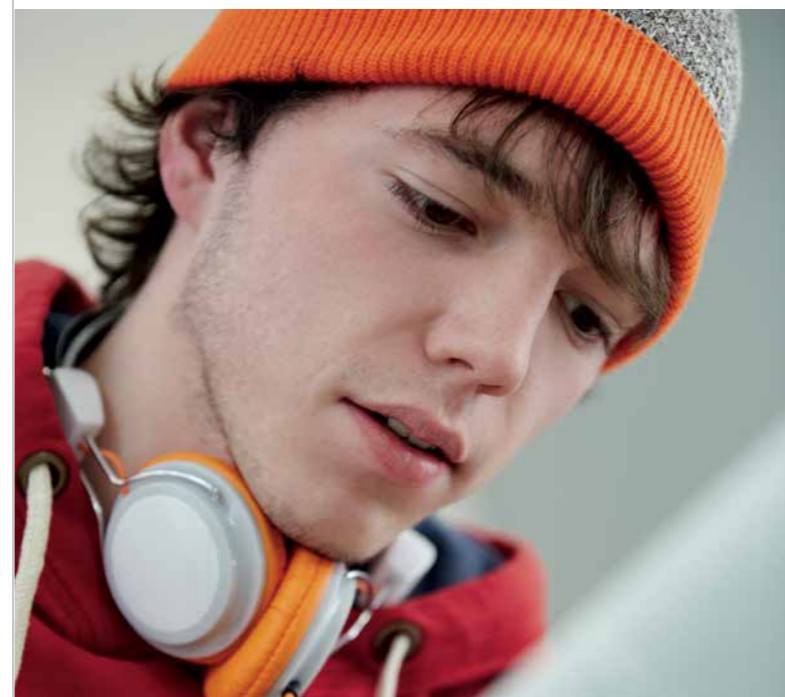
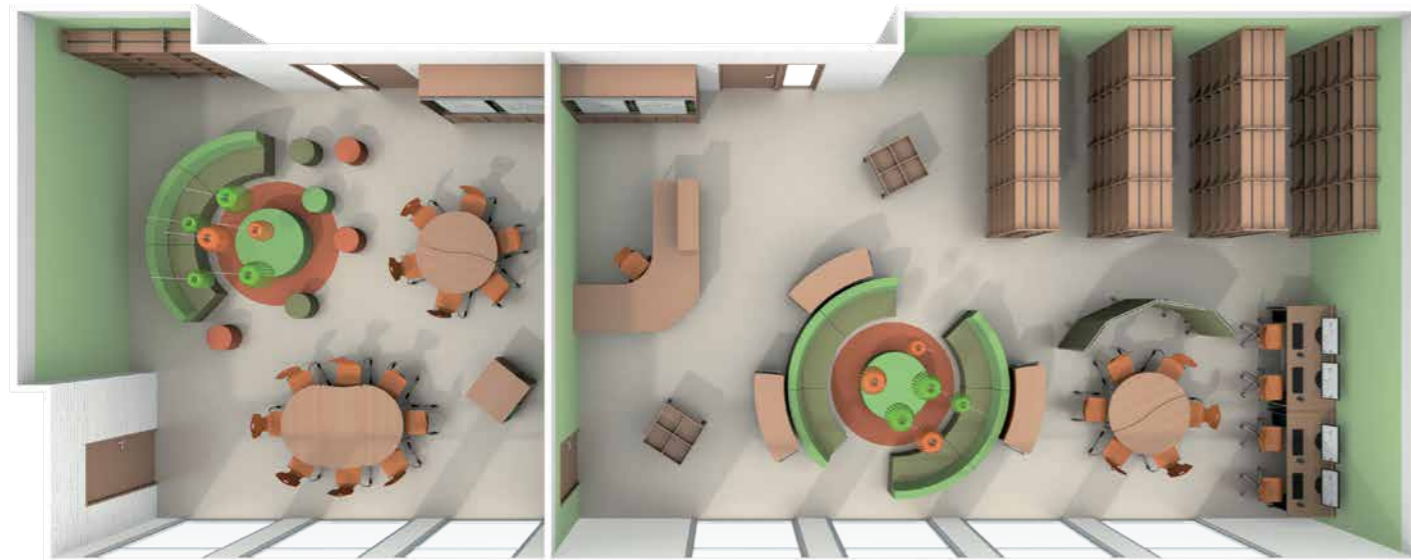

The nook cube with Tidy-boxes is open on all sides and can be used as a mobile island for teaching materials.

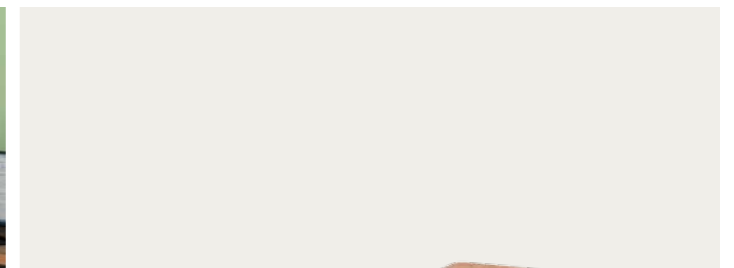
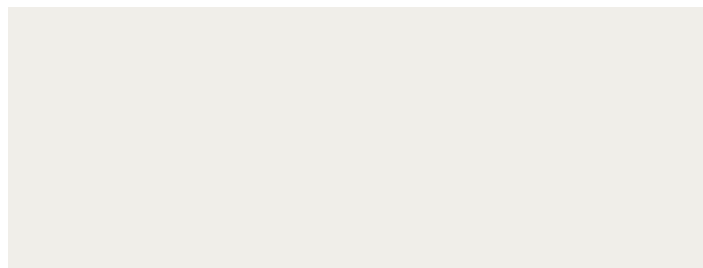

INTEGRATION OF TRAFFIC AREAS

THE LEARNING CONCEPT MOVES INTO THE HALLWAYS.

This group room is special in that it integrates the hallway areas. With this form of expansion of the learning areas, the challenge is not only to integrate the hallway in an optically and functionally meaningful manner, but also to meet the specific regulations for hallway areas (for example evacuation paths, fire safety regulations). The room should be used as flexibly as possible by students in different classes. It serves the students as a central lounge area for interacting in and as a protected retreat area for relaxing in as well as being a good place for internet research, group work, or as a meeting point for the morning circle.



Zoning for conference



Zoning for morning circle



Hallway area with zoning for groups- and partner work

Stackable tables and chairs make room for many ideas. The casters on the table feet make it easier and faster to remodel the areas for any occasion.



CAFETERIA

The cafeteria or dining hall has an important social function beyond merely providing a venue for eating together. Especially in all-day school, it is a place to meet, relax, and recharge. In order to create a sense of comfort in rooms as big as this, acoustics play an important role in the design. Frequently, the cafeteria area is also combined with the lobby and event area and used for extracurricular activities.

The cafeteria is correspondingly zoned in the different organizational models and supply systems. Depending on how the food or cooking are integrated into the pedagogic concept of the school, open cooking stations for students can also be integrated.



CAFETERIA A MEETING POINT FOR EVERY TIME OF THE DAY.

This cafeteria of a school with all-day care is directly connected to a canteen. Two snack counters - with and without staff - ensure short distances and help prevent lines, even during peak times. The inviting atmosphere of the cafeteria is created by the harmonic colour palette and the natural materials, such as domestic wood from sustainable forestry. The integrated lounge elements are equipped with hygienic, washable materials which are extremely resistant. The generous zoning of the room allows for flexible changes and offers plenty of retreat possibilities. The cafeteria is a popular meeting point not just during the day but also during evening events.



The texture of Pagholz® chair seats is both appealing and extremely resistant. The school logo is located on the back side of the backrests.





CAFETERIA & ASSEMBLY HALL DAILY NUTRITION AND EVENING PROGRAMME ALL IN ONE.

The large cafeteria can be divided in two by a built-in retractable wall to produce space for an assembly hall with a variable podium and stackable auditorium seating.

During its secondary use, the cafeteria can continue to operate independently and uninterrupted in the separate area.

The self-service area next to the service window also provides the possibility of enjoying snacks and beverages even when the cafeteria is closed.

The mobile podium and step elements work together to provide a sturdy and safe stage.

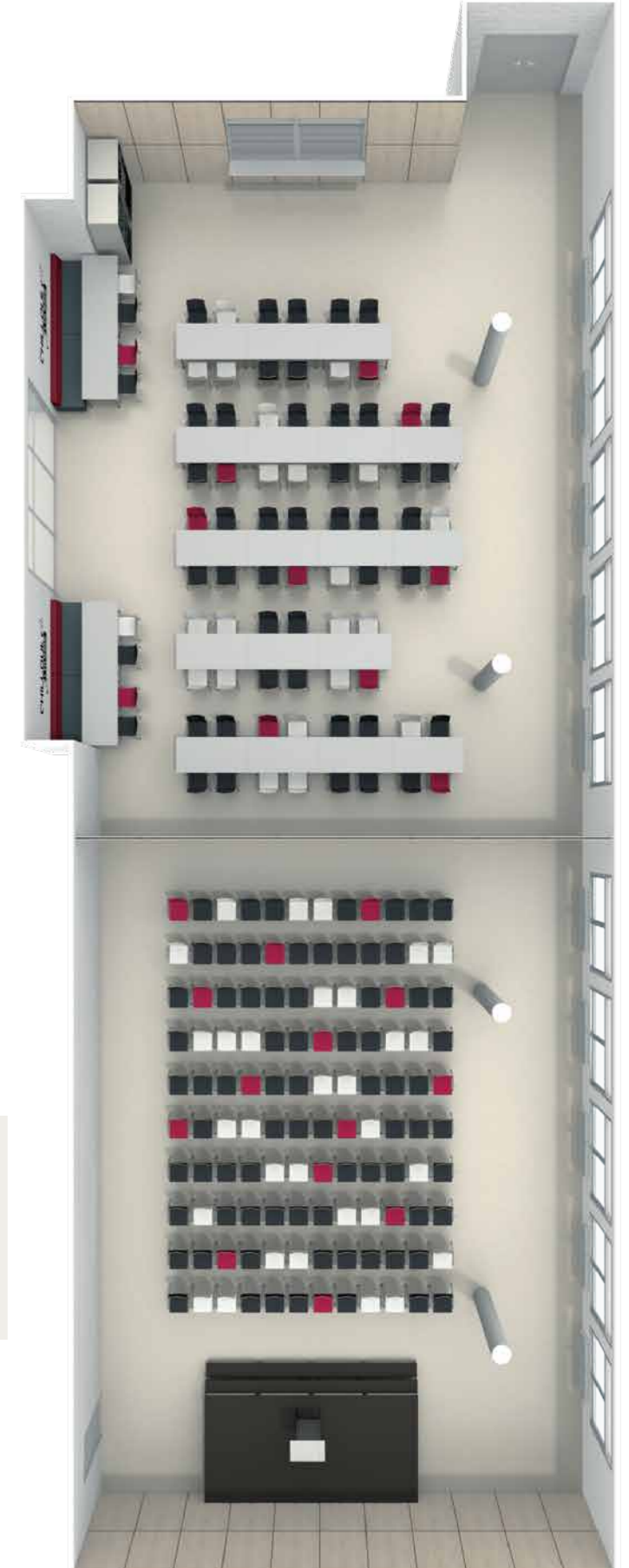

TEACHER'S WORK AREAS

The everyday life of pedagogues has changed greatly with the introduction of new learning concepts and especially all day care. Many teachers used to do much of their work at home in peace and quiet; now it is done at the work place onsite. The teacher's lounge thus has to adapt and create zones for many different needs: whether fixed or flexible work places, meeting islands or separate meeting rooms - from uninterrupted work to conferences, everything must be possible. A tea kitchen or the comfortable lounge elements form retreat areas in which to unwind and interact with colleagues in a relaxed setting. Important points for the planning are, for example, centralized or decentralized learning location, teacher's distance from students, personalized or non-personalized work places.





TEACHER'S LOUNGE REDEFINING THE TEACHER'S LOUNGE.

The teacher's lounge meets all essential requirements for a modern teacher's lounge in a cleverly zoned room. In the entry area, directly by the teaching plans, the communicative kitchen corner provides a possibility for everyday interaction. Lounge sofas, which offer a spacious and quiet retreat area, invite the teachers to relax and hang out.

In the centre of the room is an open hexagon which houses the teacher lockers and wardrobe on its outside. On the inside, there is a sound-proof retreat zone for undisturbed work or brief meetings. The individual work places are located in the honeycomb-shaped, modular COMBi system. Its sound-absorbing separating walls offer the possibility to use the room very individually and give each teacher the optimal privacy. The personal teacher caddies support a flexible pool formation for these work places.



The mobile caddies can be locked and let teachers store personal items onsite.

TEACHER'S LOUNGE WITH MEETING ROOM

PROFESSIONAL AND PERSONAL - LINKED AND SEPARATE.

This concept gives pedagogues everything they need, both for communicative interaction and for work. Sound-absorbing walls not only divide the room into several small groups but also absorb the noises in the room.

The generous lounge and kitchen area close to the entrance catches newcomers and splits the room into communication and work areas.

An additional, separate meeting room provides the fitting framework for small meetings, presentations, and conferences in a protected space.



LARGE TEACHER'S LOUNGE ITS TRUE GREATNESS LIES IN ITS LAYOUT.

A clear structure and zoning is necessary merely due to the enormous size of this room. It houses the work places for 42 pedagogues. Acoustic barriers and half-height cabinets separate work space from traffic zones and communication areas.

A comfortable communal area for interaction, protected individual work places for concentrated work, and flexible retreat areas in which to study individual topics in depth ensure that everyone can find the right place for his/her current needs.

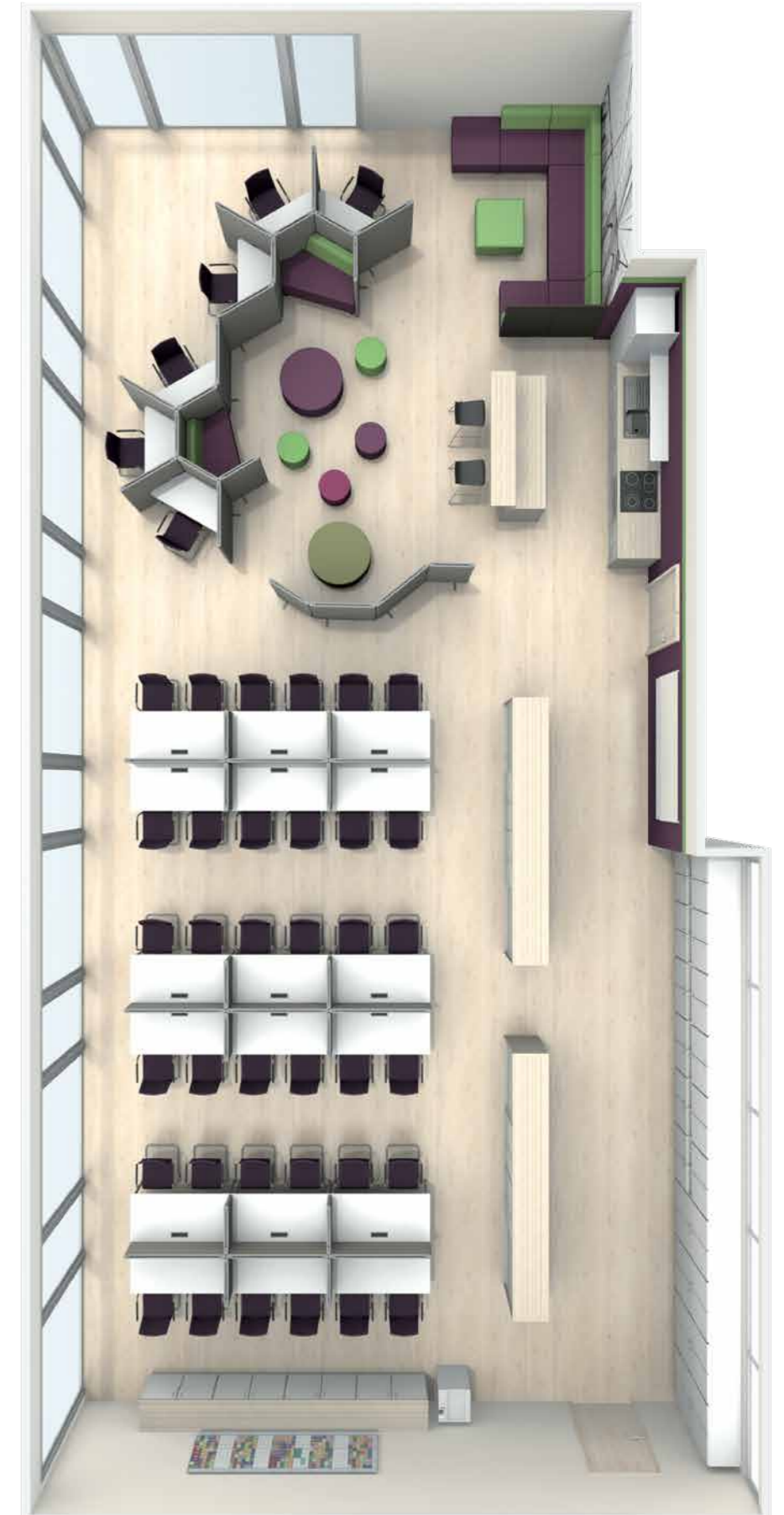

The shape of the comfortable upholstered furniture fits with the honeycomb structure of the separating walls. In combination they produce protected retreat areas.





TEAM ROOM
**ALL TOGETHER AND
EACH TO HIS OWN.**

The generous, open design of this team room for 10 pedagogues and 4 special pedagogues provides all possibilities for focused work, isolating the teachers from their colleagues.

The individual work places are protected by half-height acoustic separating walls, the walls of the meeting room are made of glass and the lounge area is separated by a semi-transparent space separator.

All work places are equipped with electric outlets. For this reason, separate IT work stations were foregone. Pharmacy cabinets with vertical drawers offer plenty of storage space.



The vertical pharmacy cabinets at the work places offer clear organization and save on unnecessary digging in drawers.



TRIPLE TEACHER'S LOUNGE
**NOT JUST A
TEACHER'S LOUNGE -
A TEACHER'S SUITE.**

The fact that everything a faculty needs can be cleverly fit into a single room, does not mean that this is the only way. This interior design concept includes 3 rooms connected to each other for the different teacher areas.

The snack area, which looks like a café, invites you to withdraw completely from the work area during breaks. The generous lounge area also permits moments of relaxation without having to think of the schedule. A separate, protected room permits undisturbed, smaller meetings, for example parent-teacher conferences.

The work area is zoned and equipped to permit focused work everywhere despite the high density of the work places.



ALL-DAY SCHOOL

In full-day schools, learning is the focus - but it is not limited to the instruction alone. After the school program in the morning, there is also a care in the afternoon. A hot lunch, supervision while learning and homework, as well as active free time, are all part of this model.

In the different action rooms, motor and cognitive skills are strengthened, and the development of creativity and social skills is promoted.

In its diversity, the all-day school concept in particular demands individual furnishing concepts.





ALL-DAY CARE FOR LONG DAYS WITHOUT BEING BORED.

In addition to traditional instruction, exercise and resting phases, eating and learning time as well as play and free time are integrated into the school day of all-day care. Since all of these phases occur in the same room, this requires flexible furniture that can quickly and easily redesign the learning room at any time.

The partition elements, which can be moved by the staff, divide a large room into two classrooms in the morning, arranged for group work, and a seating circle. After the room opens up in the afternoon, the mobile and stackable tables and benches can be used to transform the room for free time.

Whether for playing, painting, researching on the PC, or simply resting on the upholstered furniture - the right environment can be created for every need. An integrated kitchenette makes it possible to serve fresh, healthy food and drinks in the afternoon.

PRODUCTS

STUDENTS

7416.031 Chair with footrest PAGHOLZ®

7280 School table with casters

9445.180 Bench with casters

TEACHERS

8385.002 PAGHOLZ®

pneumatic spring swivel chair

7268 Teacher's desk with casters

4130.506 Teacher CHANGE caddy

RESTING AREA

5005.001 Folding couch

5030.035 CHILL bean bag Junior

5031.001 CHILL lounge cushion

5032.035 CHILL stool Junior

4130.503 CHANGE mobile cabinet w. Tidy Boxes



Instruction

Afternoon care

ALL-DAY CARE THREE CORNERS FOR MORE MOBILITY.

With our stackable triangular tables, this learning room can be converted from the morning circle, to group work, to the relaxed afternoon situation, in no time. Cabinet walls with additional add-on cabinets utilize the entire room height, offering plenty of storage space. A mobile beverage cart also ensures that the afternoon snack is always within reach.

The height-adjustable mono-column table with mobile caddy gives educators a good overview with maximum freedom of movement. The elements of the sliding panel system can easily be removed and used horizontally for work on the table.



PRODUCTS

STUDENTS

7811 PAGHOLZ® Chair C-shape

1003.118 Triangular table with casters

TEACHERS

8385.002 PAGHOLZ®
pneumatic spring swivel chair

7620.138 Elliptical mono-column table,
height-adjustable

4130.506 Teacher CHANGE caddy

PC WORKSTATION

7984.017 Stool with step

4750.600 Media workstation



ROOM SIZE: 9,0 m x 6,5 m



Seating circle



Group work



Afternoon care



MULTI-FUNCTIONAL ROOM GETS THE DAY MOVING.

The flowing lines of the S-shape tables and mobile quarter-circle shelving combinations offer an inspiring play area for afternoon care, and clearly set themselves apart from the design of other learning rooms.

Partition walls and shelves zone the room so that protected areas are created for all needs: for homework, for playing or for crafting.

The seating niche integrated in the cabinet wall and the cozy resting zone with bean bags, offer retreat areas for reading or resting.

Various wall unit combinations and shelves create plenty of storage space for games, books and crafting material.

PRODUCTS

STUDENTS

- 7416.035 Chair with footrest FLEX
- 1016.147 Rectangular table S-shape with casters
- 1018.147 Trapezoidal table S-shape with casters

TEACHERS

- 7940 Pneumatic lift stool

ZONING/MOBILE STORAGE SPACE

- 6710.070/6710.090 COMBi Acoustic partition wall, mobile
- 4130.505 Student CHANGE Caddy
- 4801.921 90° shelf cabinet, rounded
- 4004.820 shelf cabinet
- 4129.822 shelf cabinet with Tidy Boxes



THE FOOTREST CHAIR BRINGS EVERYONE TO ONE TABLE.

The footrest chair is ideal for afternoon care, which often lasts for several years for students. Its height-adjustable footrest allows larger students to sit at the same height by using a tool-free, simple one-hand operation – for learning at eye level.

- Sitting together at a uniform table size with a working height of 76 cm
- The footrest height can be adjusted easily and without tools with just one hand
- No tilting or removing the footrest
- The footrest is resistant to dirt and moisture from shoes
- Stable base and safe to get on the chair
- Up to 3 chairs can be stacked to tidy up



The fabric-covered, mobile acoustic partition walls at 4' 7.9" tall allow for quiet working without impairing the overview of the room.



HOMEWORK ROOM

DO YOUR HOMEWORK LIKE YOU'RE AT HOME.

By zoning rooms into different areas, COMBi acoustic partition walls offer workplaces with quiet atmospheres, so students can do their work in undisturbed peace. Teachers can easily move from one place to another using the lightweight pneumatic lift stool, while helping each student individually. A separate relaxation area with bean bags create a welcome retreat, all within sight of the educators and staff.



PRODUCTS

STUDENTS

7416.031 Chair with footrest PAGHOLZ®

7280 School table with casters

TEACHERS

7940 Pneumatic lift stool

ZONING

6710.070/6710.090

COMBi acoustic partition wall

COMBi

LEAVES THE BACKGROUND NOISE OUTSIDE.



- Simple and versatile system for all types of work
- Acoustic effectiveness beyond the aspect of pure room separation
- Flexible zoning and design of rooms, and inviting resting areas
- The height of the walls will not restrict the overview of the room.
- Easy to transport and repair



Triangular table
1003.118 113 x 80 cm

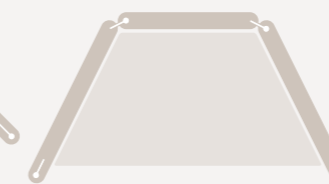

Trapezoidal table
1004.147 140 x 70 cm

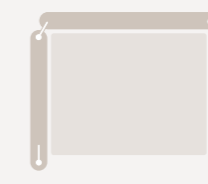

Class table
7210 70 x 55 cm



Group table
1001.088 80 x 80 cm

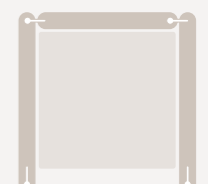

Group table
1001.077 70 x 70 cm



PLAY AND BUILD ROOM CREATIVITY AND ORDER CAN GO TOGETHER.

A playful and creative balance in class is important, especially during long school days. One also needs order in the spaces where students play and work creatively. So it's perfect when the furnishings can help to make tidying up easier, allowing more time for more fun.

The Tidy Box cabinets offer plenty of storage space for small items, like building blocks and supplies. What's more, Tidy Boxes can zone rooms into areas for play, alone or in groups. The sideboards on the walls can be used for storage, or even as exhibition areas.



The ergonomic plastic chair FLEX with Z-frame offers maximum movement, and prevents fatigue when sitting for long periods of time.

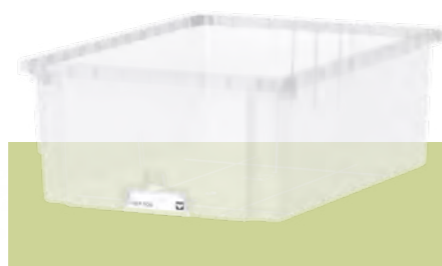

Tidy Boxes bring order to everyday school life - not just for toys. They are suitable as personal cubicles for students to learn organization and responsibility.



PRODUCTS

TABLE GROUP

FLEX Chair Z-shape **7853**

Semicircular S-shape **1019.147**

ZONING / STORAGE ROOM

Cabinet with Tidy Boxes **4129.822/4129.622**

Shelf cabinet with Tidy Boxes **4020.820**

Stool BLOC **9358.069/9358.096**

HALL FURNITURE SYSTEM THERE IS PLENTY OF SPACE IN THE HALLWAY - FOR IDEAS TOO.

The modular hall furniture system can be individually adjusted and combined to meet the structural conditions. It combines plenty of storage space, with a large variety of freely-configurable basic elements and colors.

The integrated seating niches create small meeting places for cozy breaks without having to adjust escape routes. The cabinet system also ensures safety in the hallways, because it meets the fire protection regulations and is certified as per DIN 4201 B1.

Seating groups made of SOLID tables and benches offer additional places to hang out and work in the hallway area outside of the classroom.

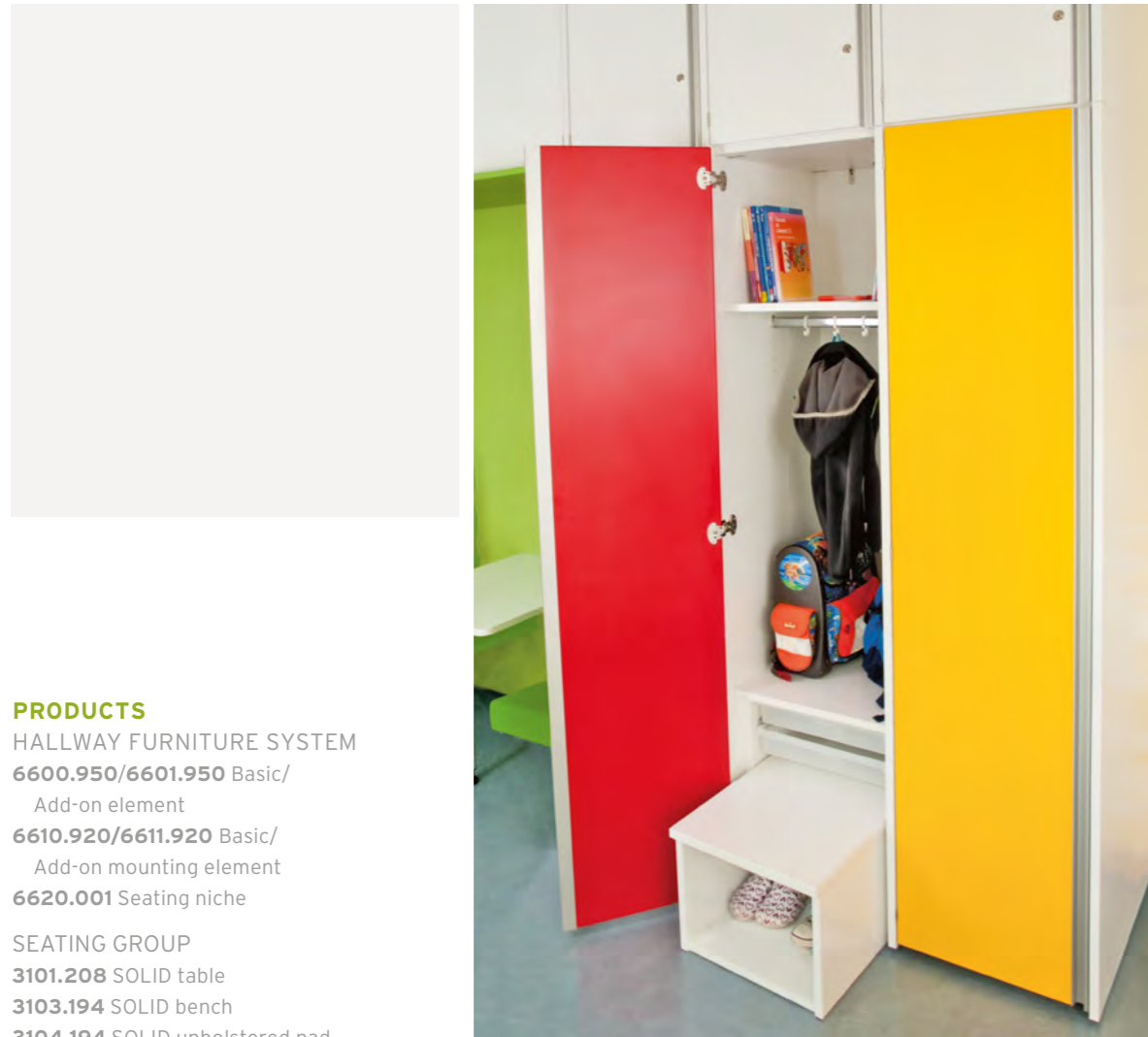

PRODUCTS

HALLWAY FURNITURE SYSTEM

6600.950/6601.950 Basic/

Add-on element

6610.920/6611.920 Basic/

Add-on mounting element

6620.001 Seating niche

SEATING GROUP

3101.208 SOLID table

3103.194 SOLID bench

3104.194 SOLID upholstered pad

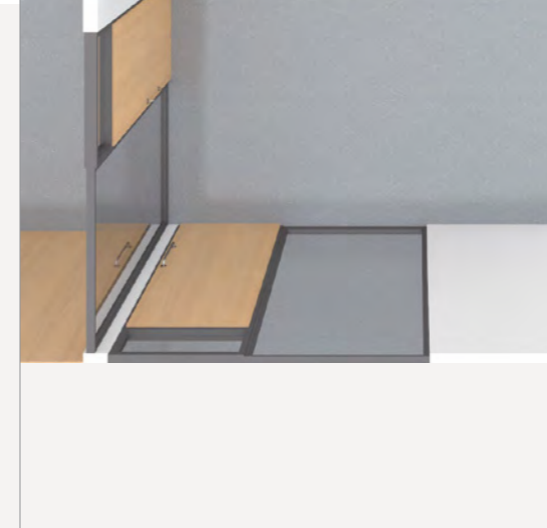

Floor-mounted SOLID tables and benches allow for additional project work with partners or in groups, outside the classroom, see furnishing example page 20



HALLWAY CABINET SYSTEM

FACTS

- flexible for various rooms and budgets
- base material as per B1 and therefore flame-retardant
- in 2 different widths for 1 or 2 students
- Tidy Boxes, which also fit under A2S tables
- pull-out stool that provides non-slip stability
- stable clothes rail for jackets
- cabinet-high handle strip, keeps the escape route clear and can be easily reached from any height
- expandable add-on cabinet with plenty of storage space
- height-adjustable base to protect against moisture
- all cabinets can be locked if desired

You can find additional information about this in our hallway furniture folder and in our product catalog.



The adjoining wardrobe ensures more order in the learning room. See furnishing example page 22.



The fixed schoolbag rack is combined with a wall-mounted coat rack. See furnishing example on page 34.

The mobile schoolbag racks can not only be used in the hallway, but also in the classroom, e.g. as a room divider. See furnishing example on page 24.

INTEGRATED WARDROBE JACKETS, BAGS AND SHOES DON'T HAVE TO STAY OUTSIDE.

These examples show classrooms with an integrated wardrobe. Clothing hooks and Tidy Boxes provide necessary order for schoolbags, jackets and shoes. To supplement the wardrobe shelves, we recommend benches for taking shoes off and putting them back on, which can also be used for the morning seating circle. All of the products shown are also suitable for use in the hallway area, depending on the specifications.

PRODUCTS

CAFETERIA

- 9421 Wall-mounted coat rack
- 4031.420 Fixed schoolbag rack

HALLWAY

- 4031.420 Mobile schoolbag rack

LEARNING ROOM

- 4032.641 Locker with hooks, fixed
- 9459.004 Solid wood bench





The food dispensing counter with an open shelf for flatware, glasses and drinks was lowered to a suitable height for children.



CAFETERIA

EATING TOGETHER STRENGTHENS THE SENSE OF TOGETHERNESS.

When children eat together, they boisterously tell stories and laugh. All the while, they are learning table manners and how to treat each other with respect.

In this furnishing example, round tables with FLEX-Z plastic chairs create a relaxed seating arrangement. The SOLID tables with upholstered benches also offer space for lots of students without specifying an exact arrangement.

A wardrobe area with schoolbag racks ensures that everyone can carry their lunch to their seat without tripping.

"EATING TOGETHER STABILIZES ONE'S OWN SOCIAL NETWORK AND IS VERY IMPORTANT TO THE SOCIAL EMBEDDING OF A PERSON."

(Prof. Thomas Ellrott,
Head of the Institute of Nutritional Psychology at the University of Göttingen)

TEACHER AREAS/ ADMINISTRATION

When it comes to new learning concepts, and especially all-day care, the everyday life of educators has dramatically changed. Those used to working at home in peace, now find themselves having to work at school as well. So the teacher's lounge must be adaptable, to create zones for lots of different needs: Whether set workstations, or workstations in a pool that can be allocated, meeting islands or separate meeting rooms - it should all be possible, from undisturbed work, to conferences.

However, kitchenettes or lounge elements, for example, create cozy retreat areas for turning it all off or having casual conversations - not just for educators, but also for school management and secretary office staff.





TEACHER'S LOUNGE TEACHERS NEED A MOTIVATING ENVIRONMENT TOO.

The furnishings in this spacious teacher's lounge clearly structures it into unique communication, work, and meeting areas, for every occasion.

Upholstered furniture invites one to have small discussions in a relaxed atmosphere. Adjoined partition walls create protected individual workstations so one can work focused, and in peace.

The open workstations on the rectangular tables are ideal for small group meetings and can be pushed together to create a large meeting table for conferences. The kitchen area with a counter and SOLID tables is a meeting point for casual conversations with colleagues.

PRODUCTS

WORK/MEETING

7414 WAVE cantilever chair

1001.188 Rectangular table

INDIVIDUAL WORKPLACE

9335 WAVE office swivel chair

1004.147 Trapezoidal table

6710.070/6710.090

COMBi acoustic partition wall

LOUNGE AREA

9387.147/9387.002

MAZE upholstery series

9359.090/9359.045 CYLINDA stool

WARDROBE

4419.850 Open locker

6620.002 Seating niche



- 1 The open kitchen with counter creates a communicative atmosphere.
- 2 In the mailbox cabinet, each teacher has their own personal open and lockable compartments.
- 3 The rectangular work tables can be pushed together to form a large conference table.
- 4 The islands made of COMBi partition walls and MAZE upholstered elements allow for small meetings and concentrated work at the same time.
- 5 The locker makes sure chair backs remain clear and create a tidy overall impression.



TEACHER/TEAM OFFICE FOR SOME CONCENTRATION IN BETWEEN.

Whether preparing or doing follow-up work for teachers, teaching means more than just 45 minutes in the classroom. You will find the right framework here for all of this work. Electrically height-adjustable tables allow for varied working while sitting and standing, which keeps the body and mind awake and focused longer.

The pharmacist's cabinet between the workstations offer plenty of storage space, with added privacy. The comfortable lounge sofa invites you to take small relaxing breaks.



MEETING / TEAM ROOM FOR SOME INSPIRATION NOW AND AGAIN.

You need a breather from time to time if you spend the whole day in a lively environment with children. This small meeting room leaves the everyday school life outside. Comfortable, upholstered furniture in natural colors, create a pleasant atmosphere for team meetings, smaller conferences, presentations or parent-teacher meetings.

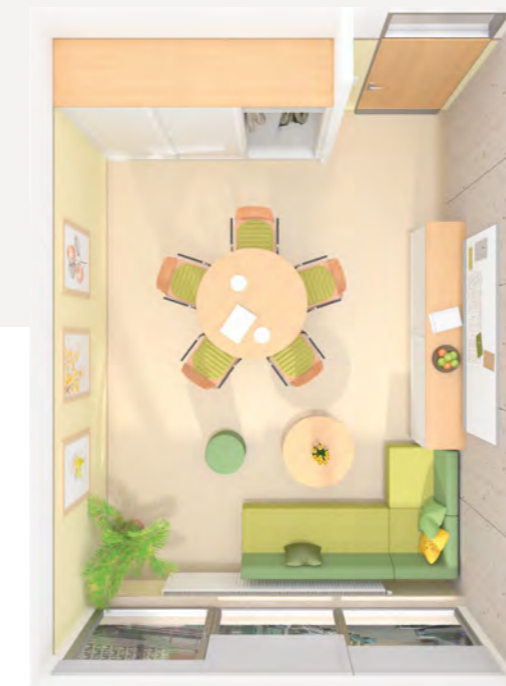

You will find an overview of our fabric and material selection at the end of this brochure.

PRODUCTS

WORKING

9335 WAVE office swivel chair

5580.148 OFFICE table
electrically height-adjustable

9133.080 Pharmacist pull-out

REST

9396.168 upholstered element Comfort HI

9386.001 Laptop table

9358.042 BLOC stool

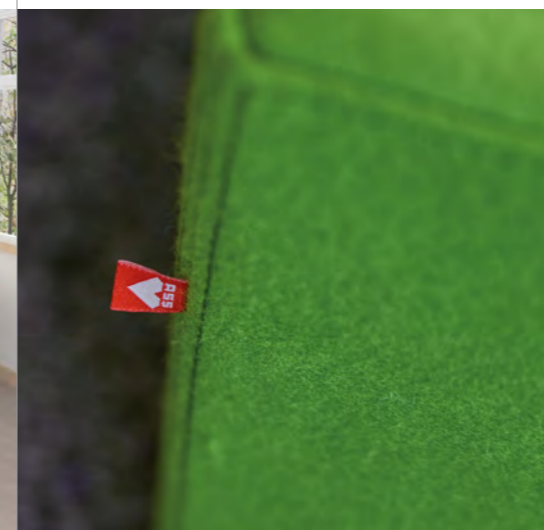

PRODUCTS

MEETING

WAVE cantilever chair 7424
Circular table 2006.120

LOUNGE AREA

9384.070/9384.301R
DOMINO upholstered series
CYLINDA stool 9359.045
CYLINDA table 2006.000



OFFICE FOR SCHOOL MANAGEMENT A WARM WELCOME.

A visit to the office is often a bit exciting. But once you have entered this room, you are instantly in a state of relaxation. The personal touch and the homey character create a welcoming and trusting atmosphere.

PRODUCTS

WORKING

- 9322.002 COMFORT swivel chair
- 5585.249 L-shape desk
- 9232.800 Handle-free filing cabinet on casters

MEETING

- 9265.002 COMFORT cantilever chair
- 2007.240 Elliptical meeting table

LOUNGE AREA

- 9394.144/9394.212 Upholstered series COMFORT LO
- 2006.000 Circular table



SECRETARY'S OFFICE WHERE ALL THREADS RUN TOGETHER.

Those who need to be accessible from all sides, often need a space that allows some separation and concentrated work. The reception counter prevents visitor access, and a small, discreet waiting area in the wall niche are just two of the features that help here.



PRODUCTS

WORKING

- WAVE office swivel chair 9335
- Desk L-shape 5585.249
- Filing cabinet on casters 9232.800

COUNTER

- Hanging filing system cabinet 4161.620
- Roller shutter cabinet 4531.920
- Tabletop shelf 4124.500
- Custom-made cover panel

WAITING AREA

- 1-door cabinet 4402.450
- Tabletop shelf 4121.410/4121.810
- Seating niche 6620.002



A2S CHAIR SERIES

Plastic	12	20				
PAGHOLZ® WOODMARK	14	16	18	30	20	
Multiplex	20	22	22	24	24	
Solid wood	26	26	26			
Office chairs Conference chairs Upholstered chairs	28	28	30	30	32	33
Stacking transporters for chairs	34	34	34	34		
Stools Benches	36	36	36	36	38	38
Standing/sitting combinations	40	41	41	42	42	

Further frame variants and all options for the chairs shown can be found on the pages indicated.



FLEX | PLASTIC SHELL

ERGONOMICAL, PRACTICAL, GOOD.

The longer a school day lasts, the more the concentration tends to suffer. Here is where good seating alone can be used to great effect - it ensures improved attention levels and therefore facilitates learning. With the Flex, we have developed a chair which convinces users through its innovative concept: Pupils can vary their seating positions repeatedly, and thus remain concentrated for longer. In this way, Flex ensures a comfortable and relaxed learning environment in the classroom. Thanks to its intelligent design and durability, Flex is a very worthwhile purchase.

FLEX BRINGS MOVEMENT INTO THE LESSON.

Due to its shape, Flex supports the toning of muscles and relieves strain on the back thanks to the flexibility of the frame. Pupils can vary their seating positions, which prevents fatigue. Integrated ventilation channels ensure comfortable seating even on hot days.

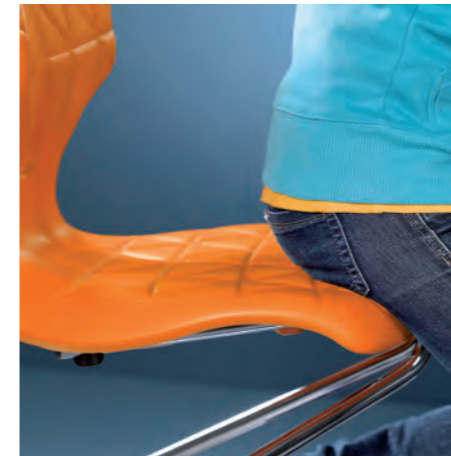

Supports the toning of the muscles through its ergonomic shape and promotes variable, fatigue-free sitting, e.g. saddle sitting



FLEX seat shell with integrated ventilation ducts. The closed surface prevents soiling and thus the formation of mould inside the shell



A2S FLOORSAFE® floor protectors protect the underground, even when tilted, Patent # 10 2010 039 292 A1

KIND TO NERVES, FLOOR AND BUDGET.

You can also rely on Flex even when tipping backwards and forwards: it has been crafted in a particularly robust and stable manner, and is gentle on floors too, even when tipped, thanks to the unique A2S floorsafe® floor protectors.

ADVANTAGES

- **Sturdy design**
- **Easy to carry for every age group**
- **Easy to stack**
- **Easy to put up for cleaning**
- **Easy to clean surface**



7853
FLEX with the worldwide patented Z-shaped frame

FLEX | PLASTIC SHELL



- ergonomically shaped plastic shell made of robust, recyclable polypropylene in 7 attractive colours, see A2S material overview
- inverted sitting, saddle sitting and casual sitting are additionally supported by the design
- easy cleaning due to special A2S surface structure
- channel for ventilation and relief of the spinal column
- grip hole in the lordosis area, grip recesses on the upper back edge and underside of the chair
- available in many different frame shapes or with base also in powder coating, the colour selection of the steel colours can be found on our A2S material overview



7854 FLEX C-shape with cross brace, with A2S FLOORSAFE® floor protectors, liftable



7874.002 FLEX 4-legged with writing surface



7416.046 FLEX footrest chair with large seat shell and comfortable one-handed operation*



7854 FLEX C-shape with upholstery



7873/7876 FLEX gas-lift swivel chair



7873.002 FLEX gas-lift swivel chair with foot ring

78 SERIES | FLEX



MODEL	7874	7853	7854	7416.045/.046	7876/7873	7875
Powder-coated frame	4-legs	Z-shape	C-shape	Footrest chair	Gas-lift I/II	Turning spindle
Powder-coated base					Aluminium	Steel
Size	2-7	2-7	2-7	1-4/3-4, 40 cm	3-5/5-7	5-7
Seat height				27-38/36-40 cm	33-43/41-54 cm	41-53 cm
Distance seat to floor				52 cm/48 cm		
Weight · size 6	5.4 kg	6.3 kg	5.4 kg	6.2 kg/7.3 kg	7.3 kg	7.4 kg
Stackability	3 pieces	2 pieces	4 pieces	3 pieces		

OPTIONS

Chrome-plated frame	■	■	■	■	Polished ALU	Polished ALU
Plastic base					- / 7873.200	
Upholstery shell · size 5-7	■	■	■		- / ■	■
A2S FLOORSAFE®		■	including			
Felt floor protectors	■	■	■	■	■	■
Teflon floor protectors	■					
Row connection			■			
Table suspension					- / 7873.005	
Plastic base & table suspension					- / 7873.205	
Castors, load-dependent braking					■	■
3D rocker mechanism					■	
Partial foot ring					■	
Elevation with foot ring 53-73 cm					7873.002	
Plastic base with foot ring					- / 7873.202	
Cross brace · size 5-7			■			
Book storage basket · size 5-7	■		■			
Writing surface · size 6/7	7874.002					
Stack transporter 3460 **	max. 5 chairs	max. 4 chairs	max. 6 chairs	max. 3 chairs		
Stack cart 3758.003 **	max. 3 chairs	max. 2 chairs	max. 2 chairs			

*The adjustable footrest allows small and large children to sit together at the same table - learning at eye level **info p. 34-35



The footrest chair is available with either a Pagholtz® or a Flex seat pan. With its two different sizes, it creates the optimum situation for learning across year groups.

FOOTREST CHAIRS

IT IS EASIER TO LEARN AT EYE LEVEL.

Modern pedagogical concepts place new demands on the learning environment - in large part because of increasingly heterogeneous composition of learning groups. Unlike conventional classrooms, children of different age groups are frequently learning together simultaneously. With noticeable differences in students' body sizes, especially in elementary schools and childcare programs, this can present an issue.

The learning concept of teaching at eye level is on the rise. It is important that every student can meet one another at eye level. Previously, height-adjustable furniture was used to compensate for these differences in height. Unfortunately, these differences still exist, even with varying table and chair heights. The A2S footrest chair was developed specifically to allow people of different heights to learn together at eye level, at the same table. By simply adjusting the footrest, everyone from young to old, and even the teachers, can sit together in comfort, at the same table.



Chairs with a small and a big seat pan at a uniform table height of 76 cm (ISO 6)



Up to 3 chairs can be stacked



Our footrest can be conveniently and safely adjusted to the proper height, in just one simple action



Floor protectors with tip protection and interchangeable inserts made of plastic or felt



Chair with a small pan for children of 108-159 cm and with a large seat pan for children of 119-176 cm



7811 PAGHOLZ®
C-shape sliding chair,
5 chairs stackable



Resistant to chemicals



Scratch- and wear-resistant



Shock- and break-proof

78 SERIES | PAGHOLZ® SHELL



- PAGHOLZ® shell: resilient because it is scratch- and impact-resistant, break-proof and glow-resistant, water resistant and flexible (info p. 171)
- ergonomically adapted shell shape or any size from 2-7 (info p. 8-9)
- individual seat depth for each shell size
- optional with round or oval grip hole on top
- PAGHOLZ® shell in Colour Wood stained possible, see A2S material overview
- seat and back upholstery possible in fabric groups 1-4, see A2S material overview
- available in many different frame shapes or with base also in powder coating, the colour selection of the steel colours can be found on our A2S material overview



7805 Sliding chair with seat upholstery



7850.012 Four-legged chair with writing surface



7416.042 Footrest chair with large seat shell and comfortable one-hand operation*



7899 Bar stool



8385.002 Gas-lift swivel chair with foot ring



8345/8385 Gas-lift swivel chair with partial foot ring

78 SERIES | PAGHOLZ® SHELL



MODEL	7800/7805	7850	7811	7416.040/.041	7416.042	7899	8345/8385	7847
Powder-coated frame	Sliding chair	4-legged	C-shape	Footrest chair	Footrest chair	Bar stool	Gas-lift I/II	Turning spindle
Powder-coated base							Aluminium	Steel
Size	2-7/6E	4, 5, 6E, 7	2-7	2-5, 42 cm/2-5	3-4, 40 cm	78 cm	3-5/5-7	5-7
Seat height				31-42 cm	36-40 cm	78 cm	31-42 cm/ 41-56 cm	40-58 cm
Distance seat to floor				53 cm/52 cm	48 cm			
Weight · size 6	4.8 kg/5 kg	5.1 kg	5 kg	5.8 kg	6 kg	8.5 kg	7.5 kg/9 kg	6.2 kg
Stackability · size 6	7 pieces	10 pieces	5 pieces	3 pieces	3 pieces			

OPTIONS

Chrome-plated frame	■	■	■	■	■	■	■	Polished ALU
PAGHOLZ® shell Colour Wood	■	■	■	■	■	■	■	■
A2S FLOORSAFE®				including				
Felt floor protectors	■	■	■	■	■	■	■	■
Teflon floor protectors		■						
Upholstery seat/back only 6E, 7	- / ■	■	■				- / ■	■
Row connection		7860	■					
Table suspension							- / ■	
Handle hole (n.w. back upholstery)	■	■	■	■	■	■	■	■
Castors, load-dependent braking							■	7849
2D rocker mechanism lockable							- / ■	
Partial foot ring							- / ■	
Elevation with foot ring 46-66 cm								8385.002
Cross brace · size 5-7				■				
Writing surface only 6E		7850.012						
Stack transporter 3460**	max. 7 chairs	max. 10 chairs	max. 8 chairs	max. 3 chairs	max. 3 chairs			
Stack cart 3758.003**	max. 7 chairs	max. 10 chairs	max. 5 chairs					

*The adjustable footrest allows small and large children to sit together at the same table **info p. 34-35



7200 Sliding chair PAGHOLZ® shell nature
15 pieces stackable



Resistant to chemicals



Scratch- and wear-resistant



Shock- and break-proof

72 SERIES | PAGHOLZ® SHELL



- ergonomically adapted shell shape in sizes 2-7, thus universally applicable
- PAGHOLZ® shell: CO₂-neutral through natural materials, therefore very ecological (info p. 171)
- extra stable shape with comfortable, straight back
- optional with round or oval grip hole on top
- PAGHOLZ® shell in Colour Wood stained possible, see A2S material overview
- seat and back upholstery possible in fabric groups 1-4, see A2S material overview
- available in many different frame shapes or with base also in powder coating, the colour selection of the steel colours can be found on our A2S material overview



7205 Sliding chair



3305 Four-legged chair



7307 C-shape sliding chair



8346/8386 Gas-lift swivel chair



8386 Gas-lift swivel chair
with partial foot ring



8386.002 Raised gas-lift swivel chair
with foot ring

72 SERIES | PAGHOLZ® SHELL



MODEL	7200/7205	3305	7307	8346/8386	7846
Powder-coated frame	Sliding chair	4-legged	C-shape	Gas-lift I/II	Turning spindle
Powder-coated base				Aluminium	Steel
Size	2-7/6E, 7	6E, 7	2-7, 6E	3-5/5-7	5-7
Height adjustability				31-42/41-56 cm	40-58 cm
Weight · size 6	4.9 kg	4.4 kg	4.9 kg	6.1 kg/8 kg	6.3 kg
Stackability without upholstery · size 6	15 pieces	13 pieces	5 pieces		

OPTIONS

Chrome-plated frame	■	■	■	Polished ALU	
PAGHOLZ® shell Colour Wood	■	■	■	■	■
A2S FLOORSAFE®			including		
Felt floor protectors	■	■	■	■	■
Teflon floor protectors		■			
Upholstery seat/back only 6E, 7	- / ■	■	■	- / ■	■
Row connection only 6E, 7		3205	■		
Handle hole (n.w. back upholstery)	■	■	■	■	■
Castors, load-dependent braking				■	7826
2D rocker mechanism lockable				- / ■	
3D rocker mechanism				■	
Partial foot ring				- / ■	
Elevation with foot ring 46-66 cm					8386.002
Cross brace · size 5-7			■		
Stack transporter 3460*	max.15 chairs	max.13 chairs	max.5 chairs		
Stack cart 3758.003*	max.15 chairs	max.13 chairs	max.5 chairs		

*info p. 34-35



7802 CHANGE sliding chair PAGHOLZ® shell Coffee 210 stained
7270 CHANGE school desk PAGHOLZ® board Coffee 210 stained

CHANGE SERIES | PAGHOLZ®



- PAGHOLZ® shell: resilient because it is scratch- and impact-resistant, break-proof and glow resistant, water resistant and flexible (info p. 171)
- different comfortable sitting positions when sitting invertedly
- filigree, robust chair frame made of 16/2 mm thick, chromed round tube with plastic floor protectors
- PAGHOLZ® seat shell and table top in PAGHOLZ® natural or Colour Wood Coffee 210 stained, see A2S material overview
- seat and back upholstery possible in fabric groups 1-4, see A2S material overview



Resistant to chemicals



Scratch- and wear-resistant



Shock- and break-proof



7270 4 tables stackable



7813 C-shape 5 chairs stackable



Standard incl. A2S piggyback equipment

Standard incl. A2S FLOORSAFE® as standard

7813 CHANGE chair C-shape
7270 CHANGE School desk

CHANGE CHAIR



MODEL	7802	7813
Frame	Sliding chair	C-shape
Size	6	6
Weight	8 kg	4.3 kg
Stackability	5 pieces	5 pieces

OPTIONS

Chrome-plated frame	including	■
Powder-coated frame		including
A2S FLOORSAFE®		including
Felt floor protectors	■	■
Upholstery seat/back	■	■
Row connection		■
Cross brace		■
Use	Training and seminar rooms Classrooms	Training and seminar rooms Classrooms
Stack transporter 3460 *	max. 5 chairs	max. 5 chairs
Stack cart 3758.003 *	max. 5 chairs	max. 5 chairs

*info p. 34-35

CHANGE SCHOOL DESK



MODEL	7270
Frame	1-seater
Size	6
Panel dimensions	70 x 55 cm
Weight - size 6	18 kg
Stackability	4 pieces

OPTIONS

Chrome-plated frame	including
Felt floor protectors	■
Use	Training and seminar rooms Classrooms



7100 WOODMARK sliding chair with C-shape frame
Scratch-resistant seat and back surface
available in many fresh colours



71 SERIES | MULTIPLEX/WOODMARK

- ideal for small rooms with little space, as no chair legs disturb when getting in and out
- extremely robust and durable due to the solid construction
- stable welded oval tube made of 2 mm thick steel, scratch-resistant because powder-coated
- scratch-resistant wood surface due to our unique WOODMARK melamine resin coating
- WOODMARK seat and back available in stained Colour Wood, see A2S material overview
- seat and back upholstery possible in fabric groups 1-4, see A2S material overview



6100 | PLASTIC CHAIR

- seat and back made of polypropylene, recyclable
- ergonomically shaped with integrated ventilation channels
- seat and back available in red, blue and grey
- optional with felt floor protectors with kick protection
- in sizes 5 - 7
- frame in RAL 9006 chrome silver



WOODMARK seat
with embossed nubs for
non-slip seating



Floor protectors
with kick protection



7100 WOODMARK C-shape
sliding chair,
5 chairs stackable



7130/7132 Sliding chair,
3-way height adjustable frame



7120 C-shape sliding chair
with writing surface



6100 Sliding chair
with seat and back made of plastic



8383 Gas-lift swivel chair



8382 Gas-lift swivel chair
with partial foot ring



8382.002 Gas-lift swivel chair
with foot ring

71 SERIES | MULTIPLEX/WOODMARK



MODEL	7110	7100	7130/7132	8342/8382	7950
Design	Multiplex seat without nubs	WOODMARK seat with nubs	WOODMARK seat with nubs	WOODMARK seat with nubs	WOODMARK seat with nubs
Powder-coated frame	C-shape	C-shape	height adjustable	Gas-lift I/II	Turning spindle
Powder-coated base				Aluminium	Steel
Size	2-7	2-7	3-5/5-7	3-5/5-7	5-7
Height adjustability			34-42/42-50 cm	31-42 cm/41-56 cm	41-59 cm
Weight · size 6	6.7 kg	6.7 kg	8 kg/11.3 kg	9 kg	8.8 kg
Stackability without upholstery · size 6	5 pieces	5 pieces	3/4 pieces		

OPTIONS				
Seat and back WOODMARK		including	including	including
Seat and back plastic · size 5-7	6100			
WOODMARK Colour Wood		■	■	■
Polished ALU frame			■	
Felt floor protectors	■	■	■	■
Upholstery seat/seat + back · size 6		7105/7106		8383/8384
Row connection	■	■		
Castors, load-dependent braking				■ 7960
Partial foot ring				- / ■
Elevation with foot ring 50-70 cm				- / 8382.002
Writing surface · size 6-7		7120		
Stack transporter 3460*	max. 10 chairs	max. 10 chairs	max. 3/4 chairs	
Stack cart 3758.001*	max. 5 chairs	max. 5 chairs		

*info p. 34-35



Also with seat upholstery up to 9 chairs vertically stackable due to stacking bar



Optional with panic-proof row connection; rows of chairs in rooms with more than 20 seats, e.g. also in the auditorium, must be linked according to §10/1 of the Assembly Rooms Ordinance

7470.003
Four-legged chair with seat and back upholstery

74 SERIES | MULTIPLEX SHELL



- vertically stackable up to 9 chairs
- micro-alloyed, 20/1.5 mm thick, chromed round steel tube
- solid beech multiplex shell, environmentally friendly varnished with water-based lacquer
- optional with trapezoidal grip hole on top
- shell Multiplex veneer direction lengthwise in Colour Wood stained possible, see A2S material overview
- shell Multiplex veneer direction transverse with CPL-coating with especially scratch-resistant surface possible, but without grip hole, see A2S material overview
- on request with seat and back upholstery in fabric groups 1-4 possible, see A2S material overview



7470.003 Four-legged chair



7471.010 Four-legged chair with row connection, with CPL-coated pan



7470.004 Four-legged chair



7419.010 Cantilever chair



7429.011 Cantilever chair



8379 Gas-lift swivel chair

7470 SERIES | MULTIPLEX SHELL



MODEL	7470.003	7470.004	7470.010	7819.010	7419.010	7419.011	8379
Frame	4-legged	4-legged	4-legged	C-shape	Cantilever chair	Cantilever chair	Gas-lift
Size	6	6	6	6	6	6	5-7
Weight	5.4 kg	5.4 kg	6.7 kg	8.1 kg	6.5 kg	7.5 kg	7 kg
Stackability (also with upholstery)	9 pieces	9 pieces	9 pieces	5 pieces	5 pieces		

OPTIONS

Chrome-plated frame	including	including	including	■	including	including	Polished ALU
Powder-coated frame				including			including
Plastic base							8379.200
Shell veneer direction	longitudinal	longitudinal	transverse	transverse	transverse		transverse
Multiplex Colour Wood	■	■					
Shell CPL coating (without grip hole)			■	■	■		■
A2S FLOORSAFE®				including			
Felt floor protectors	■	■	■	■	■	■	■
Teflon floor protectors	■	■	■				
Seat upholstery	■	■	■	■	■	including	■
Back upholstery	■		■	■	■	including	■
Row connection	7471.003	7471.004	7471.010				
Armrests					7429.010	7429.011	
Handle hole (n. w. CPL/back upholstery)	■		■	■	■		■
Castors, load-dependent braking							■
3D rocker mechanism							■
Partial foot ring							■
Elevation with foot ring 46-66 cm							8379.002
Plastic base with foot ring							8379.202
Cross brace				■			
Stack transporter 3460*	max. 12 chairs	max. 12 chairs	max. 12 chairs	max. 5 chairs	max. 5 chairs		
Stack cart 3758.003*	max. 9 chairs	max. 9 chairs	max. 9 chairs	max. 5 chairs			

*info p. 34-35



7470.009
Beech multiplex shell round with four-legged frame in many attractive colours, optionally with kidney-shaped grip hole



7822 Optional with seat and back upholstery



Up to 9 chairs stackable, also with upholstery



7470.005 Optional with seat and back upholstery



7470.005 Beech multiplex shell, waisted and colour stained with four-legged frame, optionally with trapezoidal grip hole



Up to 9 chairs stackable, also with upholstery

74 SERIES | MULTIPLEX SHELLROUND/WAISTED

- classic seat shell shapes for all applications
- made of solid beech multiplex, environmentally friendly varnished with water-based lacquer
- micro-alloyed, 20/1.5 mm thick, chromed round steel tube
- optional with kidney-shaped grip hole at the top for round shells and trapezoid-shaped shells with a waisted cut
- shell Multiplex in Colour Wood stained possible, see A2S material overview
- on request with seat and back upholstery in fabric groups 1-4 possible, see A2S material overview



74 SERIES | MULTIPLEX ROUND SHELL



MODEL	7470.009	7822	8338/8378
Frame	4-legged	C-shape	Gas-lift I/II
Powder-coated frame		■	■
Base			Aluminium
Size	6	2-7	3-5/5-7
Height adjustability			31-42 cm/41-56 cm
Weight · size 6	6.8 kg	8 kg	7 kg/8 kg
Stackability without upholstery · size 6	9 pieces	9 pieces	

OPTIONS

Chrome-plated frame	including	■	Polished ALU
Plastic base			8378.200
Shell veneer direction	longitudinal	longitudinal	longitudinal
Multiplex Colour Wood	■	■	■
A2S FLOORSAFE®		including	
Felt floor protectors	■	■	■
Teflon floor protectors	■		
Seat upholstery size 6, 7	■	■	- / ■
Back upholstery size 6, 7	■	■	- / ■
Row connection	7471.009	■	
Handle hole (n.w. back upholstery)	■ kidney shape	■ kidney shape	■ kidney shape
Castors, load-dependent braking			■
2D rocker mechanism lockable			- / ■
3D rocker mechanism			- / ■
Partial foot ring			- / ■
Elevation with foot ring 46-66 cm			8378.002
Plastic base with foot ring			8378.202
Cross brace		■	
Stack transporter 3460*	max. 12 chairs	max. 8 chairs	
Stack cart 3758.003*	max. 9 chairs	max. 5 chairs	

*info p. 34-35

MULTIPLEX WAISTED SHELL



MODEL	7470.005	7818	8337/8377
Frame	4-legged	C-shape	Gas-lift I/II
Powder-coated frame		■	■
Base			Aluminium
Size	6	2-7	3-5/5-7
Height adjustability			31-42 cm/41-56 cm
Weight · size 6	5.4 kg	8 kg	7 kg/8 kg
Stackability without upholstery · size 6	9 pieces	9 pieces	

Chrome-plated frame	including	■	Polished ALU
Plastic base			8377.200
Shell veneer direction	longitudinal	longitudinal	longitudinal
Multiplex Colour Wood	■	■	■
A2S FLOORSAFE®		including	
Felt floor protectors	■	■	■
Teflon floor protectors	■		
Seat upholstery size 6, 7	■	■	- / ■
Back upholstery size 6, 7	■	■	- / ■
Row connection	7471.005	■	
Handle hole (n.w. back upholstery)	■ trapezoidal	■ trapezoidal	■ trapezoidal
Castors, load-dependent braking			■
2D rocker mechanism lockable			■ / -
3D rocker mechanism			- / ■
Partial foot ring			- / ■
Elevation with foot ring 46-66 cm			8377.002
Plastic base with foot ring			8377.202
Cross brace		■	
Stack transporter 3460*	max. 12 chairs	max. 8 chairs	
Stack cart 3758.003*	max. 9 chairs	max. 5 chairs	



7097
Solid wood chair in sizes 2-6

7097 | SOLID WOOD CHAIR

- seat and back made of ergonomically shaped, solid beech multiplex
- solid beech wood frame
- environmentally friendly sealed with water-based lacquer
- durable due to doweled, glued and screwed connections
- up to 5 chairs stackable



Solid beech wood;
environmentally friendly sealed
with water-based lacquer



Up to 5 chairs stackable



Softly rounded seat surface at
the front for comfortable sitting



52 SERIES | SOLID WOOD CHAIRS



- seat and back made of ergonomically shaped, solid beech multiplex
- frame made of solid beech wood, 55 x 30 mm thick
- environmentally friendly sealed with water-based lacquer
- chair optionally available in coloured stain, see A2S material overview
- without upholstery up to 6 chairs stackable
- seat and back upholstery possible in fabric groups 1-4, see A2S material overview

7000 | SOLID WOOD CHAIR



- seat and back made of ergonomically shaped, solid beech multiplex
- robust two-column construction made of solid beech wood, mortised and doweled
- frame, seat and back environmentally friendly lacquered with water-based lacquer



Equipment for chair
suspension: protects the table
surface and the chair remains
securely on the table

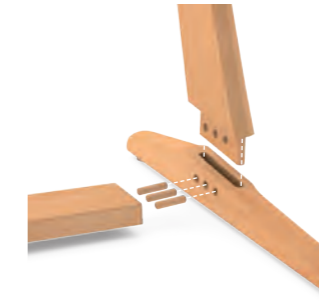

Durable due to mortised,
doweled and glued connections

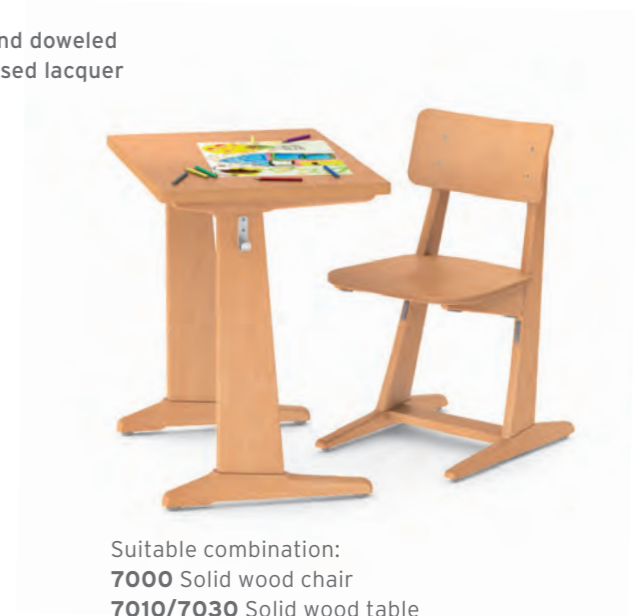

Suitable combination:
7000 Solid wood chair
7010/7030 Solid wood table

7097 | SOLID WOOD CHAIR



MODEL	7097
Frame natural varnished beech	4-legged
Size	2-6
Weight · size 6	5.9 kg
Stackability without upholstery · size 6	5 pieces

OPTIONS

Seat and back colour stained	■
Felt floor protectors	■
Seat upholstery	
Seat and back upholstery	
Stack transporter 3460 *	max. 6 chairs
Stack cart 3758.001 *	max. 5 chairs
Stack cart 3758.003 *	

*info p. 34-35

52 SERIES | SOLID WOOD CHAIRS



5261	5271
4-legged	4-legged with armrests
6	6
7.2 kg	8.6 kg
6 pieces	5 pieces

Seat and back colour stained	■	■
Felt floor protectors	■	■
Seat upholstery	5262	5272
Seat and back upholstery	5263	5273
Stack transporter 3460 *	max. 4 chairs	max. 4 chairs
Stack cart 3758.001 *	max. 4 chairs	max. 4 chairs
Stack cart 3758.003 *	max. 4 chairs	max. 4 chairs

7000 SOLID WOOD CHAIR



7000
Sliding chair
2-7
5.8 kg

Seat and back colour stained	■
Felt floor protectors	■
Seat upholstery	
Seat and back upholstery	
Stack transporter 3460 *	
Stack cart 3758.001 *	
Stack cart 3758.003 *	



9349.002 Premium office swivel chair with mesh back, with headrest and 3D armrests



9348.002 Premium office swivel chair with mesh back and 3D armrests



9352.002 Standard office swivel chair with mesh back and armrests

PREMIUM OFFICE SWIVEL CHAIR

- synchronous, dynamic movement sequence permanently movable with locking of the back in 5 positions
- seat inclination and seat depth adjustment. Adjustable back 20°, seat 6° and seat depth adjustment range 6 cm
- backrest 56 cm high
- mesh backrest black, with independent lumbar support adjustment by membrane tensioning
- fully upholstered backrest height adjustable by 8 cm, with lumbar support adjustment in the range 15 mm
- headrest on models with mesh backrest 15 cm high, mesh black, tiltable and height adjustable by 7.5 cm
- headrest on models with fully upholstered backrest 15 cm high, black leather, inclinable by 42° and height-adjustable by 6.5 cm
- 3D armrests with arm rests made of soft polyurethane, height adjustable by 8 cm, width adjustable by 3 cm, adjustable forward and backward by 5 cm
- stepless gas lift height adjustment incl. seat depth suspension: 45-56 cm
- 5-star aluminum base, polished aluminum, with load-dependent braked safety castors
- cover fabrics selectable from price group 1-4



9349.102 Premium office swivel chair fully upholstered with headrest and 3D armrests



9348.102 Premium office swivel chair fully upholstered with 3D armrests



9352.102 Standard office swivel chair fully upholstered with armrests

STANDARD OFFICE SWIVEL CHAIR

- synchronous mechanism with locking of the back in 4 positions
- seat inclination adjustable: back 22°, seat 13°
- mesh backrest black, 52 cm high, with lumbar support adjustment
- fully upholstered backrest 56 cm high, height adjustable by 8 cm, with lumbar support adjustment in the range 15 mm
- armrests with arm support in soft polyurethane, height adjustable by 8 cm
- stepless gas lift height adjustment incl. seat depth suspension: 45-56 cm
- plastic 5-star base, black nylon, with load-dependent braked safety castors
- cover fabrics selectable from price group 1-4

PREMIUM OFFICE SWIVEL CHAIR



MODEL	9349.001	9348.001	9349.101	9348.101
Base	Polished ALU	Polished ALU	Polished ALU	Polished ALU
Back	Mesh black	Mesh black	Full upholstery	Full upholstery
Headrest	Mesh black		Leather black	
Lordosis adjustment	■	■	■	■
Hard castors for soft floors	■	■	■	■
Height adjustability	45-56 cm	45-56 cm	44-55 cm	44-55 cm
Dimensions W/H/D	69/122-139/69 cm	69/105-116/69 cm	70/119-143/70 cm	70/100-116/70 cm
Weight	16 kg	15 kg	15 kg	14 kg

OPTIONS

Base aluminium die-cast black	■	■	■	■
Armrests/3D armrests	- / 9349.002	- / 9348.002	- / 9349.102	- / 9348.102
Soft castors for hard floors	■	■	■	■

STANDARD OFFICE SWIVEL CHAIR



MODEL	9352.001	9352.101
Base	Nylon black	Nylon black
Back	Mesh black	Full upholstery
Headrest		
Lordosis adjustment	■	■
Hard castors for soft floors	■	■
Height adjustability	45-56 cm	44-55 cm
Dimensions W/H/D	66/97-118/61.5 cm	70/100-116/70 cm
Weight	15 kg	14 kg

Base aluminium die-cast black	■	■
Armrests/3D armrests	9352.002 / -	9352.102 / -
Soft castors for hard floors	■	■



9335 WAVE office swivel chair
with wave-shaped seat and back upholstery genuine leather



Resistant to chemicals



Scratch- and wear-resistant



Shock- and break-proof

WAVE SERIES CONFERENCE AND OFFICE SWIVEL CHAIRS



- PAGHOLZ® shell: particularly slim design, therefore flexible and yet break-proof (info p. 171)
- PAGHOLZ® shell in PAGHOLZ® natural or PAGHOLZ® Colour Wood, colours see A2S material overview
- on request available with flat upholstery, cover fabrics selectable from price group 1-4, or with wave upholstery, cover fabrics selectable from fabric group FLEX/WAVE or genuine leather, colours see A2S material overview
- infinitely variable height adjustment from 42-51 cm by gas-lift with depth spring
- synchronous mechanism with one-hand lever adjustment
- seat inclination mechanism with weight adjustment, inclination 0° - 18° lockable in 5 positions
- 5-legged, polished die-cast aluminium frame with load dependent braked safety double castors



7414 Cantilever chair



7424 Cantilever chair with armrests



7410 Four-legged chair



7410 Four-legged chair,
5 chairs stackable without upholstery

WAVE | CONFERENCE AND OFFICE SWIVEL CHAIRS



MODEL	7410	7414	9335
Chrome-plated frame	4-legged	Cantilever chair	Gas-lift
Base			Polished ALU
Size	6	6	5-7
Height adjustability			42-51 cm
Weight	10 kg	10 kg	12.4 kg
Stackability without upholstery · size 6	5 pieces	5 pieces	

OPTIONS

	7410	7414	9335
Armrests		7424	
PAGHOLZ® Colour Wood	■	■	■
Felt floor protectors	■	■	
Teflon floor protectors	■		
Wave upholstery on seat	■	■	including
Wave upholstery on back	■	■	including
Flat upholstery on seat	■	■	
Flat upholstery on back	■	■	
Stack transporter 3460 *	max. 5 chairs	max. 8 chairs	
Stack cart 3758.003 *	max. 5 chairs	max. 5 chairs	

*info p. 34-35



9251.002 Cantilever conference chair with mesh back and armrests



9252.002 Four-legged with mesh back and armrests



9253.002 Cantilever fully upholstery with armrests



9254.002 Four-legged chair fully upholstered with armrests

CONFERENCE CHAIRS

- black mesh back, height 28 cm
- back fully upholstered, height 39 cm
- full upholstery in material groups 1-4 possible, see A2S material overview
- cantilever and four-legged frame in chrome-plated round tube, stackable
- frame optionally powder-coated in RAL 9006 chrome silver or RAL 9005 black
- optional with armrests

CONFERENCE CHAIR



MODEL	9251.001	9252.001	9253.001	9254.001
Chrome-plated frame	Cantilever chair	4-legged	Cantilever chair	4-legged
Back	Mesh	Mesh	Upholstery	Upholstery
Seat height	46 cm	46 cm	46 cm	46 cm
Dimensions W/H/D	53/83/57 cm	53/80/57 cm	53/86/57 cm	53/83/55 cm
Weight	6 kg	6 kg	8 kg	7 kg
Stackability	4 pieces	4 pieces	4 pieces	4 pieces

OPTIONS

Powder-coated frame	RAL 9006 chrome silver RAL 9005 black	RAL 9006 chrome silver RAL 9005 black	RAL 9006 chrome silver RAL 9005 black	RAL 9006 chrome silver RAL 9005 black
Felt floor protectors	■	■	■	■
Armrests	9251.002	9252.002	9253.002	9254.002
Dimensions with armrests W/H/D	60/83/57 cm	60/80/57 cm	60/86/57 cm	60/83/55 cm
Weight with armrests	7 kg	7 kg	9 kg	8 kg
Stack transporter 9250*		max. 8 chairs		max. 8 chairs

*info p. 34-35



9374.002 Lounge chair 3-coloured with 2D-rocker function



Fabric selectable in 3 colours within a fabric group



9376.001 Upholstered armchair 3-coloured, solid oak wood



9370 Gas-lift swivel chair 3-coloured with load dependent braked safety castors

UPHOLSTERED/LOUNGE CHAIR



- 1- or 3-coloured fabric cover possible in fabric groups 1-4, see A2S material overview
- upholstered gas-lift swivel chair with rocker mechanism incl. lock
- 5-arm base with load-dependently braked safety castors
- lounge chair wire frame with 2D rocker function
- four-legged frame in oak solid wood natural varnished

UPHOLSTERED/LOUNGE CHAIR



MODEL	9370	9374.001	9374.002	9376.001
Frame	Gas-lift base Polished ALU	Wire frame	Wire frame	4-legged
		RAL 9006 chrome silver RAL 9010 white RAL 9005 black	RAL 9006 chrome silver RAL 9010 white RAL 9005 black	Oak solid wood
Seat height	48-58 cm	46 cm	46 cm	46 cm
2D rocker function			■	
Dimensions W/H/D	69/82-95/63 cm	60/82/60 cm	60/74/62 cm	60/83/62 cm
Weight	14 kg	12 kg	12 kg	11 kg
Certification		GS Certificate	GS Certificate	GS Certificate

OPTIONS

Frame	RAL 9005 black	chrome-plated	chrome-plated	
Hard castors for soft floors	including			
Soft castors for hard floors	■			
Felt floor protectors		■	■	■



9250 Stack trolley with **9252.001** conference chairs

3460 Stack trolley with **7850** PAGHOLZ® 4-leg chairs



3460 Stack transporter
Installation surface adjustable at various angles of inclination



3758.001 Stack cart with **7100** WOODMARK C-form skid chairs

3758.003 Stack cart with **7470.009** Multiplex 4-leg chairs

STACK TRANSPORTER FOR CHAIRS

9250 STACK TRANSPORTER





- sturdy round tube steel frame (20 x 2 mm), scratch resistant powder coated in black 9005
- 4 swivel castors included

3460 STACK TRANSPORTER

- solid round tube steel frame (30 x 2 mm), scratch-resistant powder-coated in black-grey 7021
- including 4 swivel castors, 2 of them lockable
- installation surface adjustable at different angles of inclination

3758S STACK CART

- stable round tube steel frame (20 x 2 mm and 25 x 2 mm), scratch-resistant powder-coated in black-grey 7021
- including 2 fixed castors and 1 swivel castor
- with ergonomically shaped plastic handles

STACKING TRANSPORTERS	STACK TRANSPORTER		STACK CART	
				
MODEL	9250	3460	3758.001	3758.003
Powder-coated frame	■	■	■	■
Dimensions W/H/D	52 x 60 x 70 cm	67 x 61 x 55 cm	56 x 124 x 65 cm	70 x 124 x 75 cm
Weight	5 kg	15 kg	11.5 kg	11.5 kg
Use	stackable 4-leg conference chairs	stackable chairs	stackable C-form chairs with cross bar	stackable C-form chairs without cross brace, stackable 4-leg chairs, stackable skid-base chairs





8389 Gas-lift swivel stool with load-dependent braked castors PAGHOLZ®-seat natural



PAGHOLZ®/MULTIPLEX

- PAGHOLZ®-seat: resilient, because it is scratch- and impact-resistant, break-proof and glow-resistant, water-resistant and flexible
- all frames are scratch-resistant powder-coated
- 4-legged stool optional with foot ring or foot rests at various heights, up to 15 pieces stackable
- turning spindle with continuously welded, 5-arm steel base with plastic floor protectors, infinitely variable in height
- gas-lift with stable, 5-legged base made of die-cast aluminium, infinitely height adjustable, optional with felt floor protectors or with load-dependent braked safety double castors
- on request seat in PAGHOLZ® Colour Wood stained possible, see A2S material overview



Resistant to chemicals



Scratch- and wear-resistant



Shock- and break-proof



7984 PAGHOLZ® four-legged stools, stackable up to 15 pieces



7984.002 PAGHOLZ® four-legged stool with all-round foot ring, non-stackable



7984014/7984017 PAGHOLZ® four-legged stools with foot rests at different heights



7936 PAGHOLZ® Turning spindle stool

STOOL



MODEL	7984	7984014/7984017	8349/8389	7936
Frame	4-legged	4-legged	Gas-lift I/II	Turning spindle
Base			Aluminium	Steel
Head office	PAGHOLZ®	PAGHOLZ®	PAGHOLZ®	PAGHOLZ®
Size	6	6	2-5/4-7	5-7
Height	46 cm, 50 cm, 55 cm	55 cm/46 cm	30-41/39-54 cm	40-58 cm
Weight	3.1 kg	4 kg/3.1 kg	4.2 kg/5 kg	6 kg
Stackability	15 pieces	9 pieces		
OPTIONS				
Chrome-plated frame	■	■	Polished ALU	
Powder-coated frame	including	including	including	including
Seat multiplex	■	■	■	■
PAGHOLZ® Colour Wood	■	■	■	■
Felt floor protectors	■	■	■	■
Castors, load-dependent braking			■	7935
Foot ring	7984.002			
Various foot rests		2-5/2-4 +40 cm		



9377.001 Upholstered stool,
solid oak wood frame

TURNING SPINDLE STOOL

- upholstery made of foam
- seat upholstery available in material groups 1-4, see A2S material overview
- oak frame legs solid wood natural varnished
- upper part of the frame powder-coated, optional in RAL 9005 black or RAL 9010 white
- height adjustment by means of turning spindle



height adjustment by means
of turning spindle



upper part of the frame
powder-coated



9378 High table
9377.002 Turning spindle stool

TURNING SPINDLE STOOL AND HIGH TABLE

- frame legs of oak solid wood natural lacquered
- upper part of the frame powder-coated in RAL 9005 black or RAL 9010 white
- table frame equipped with two bag hooks
- tabletop melamine coated white or optional in solid oak
- stool height adjustable by means of a turning spindle
- table and stool with foot ring in brushed stainless steel
- stool seat upholstered, fabric as desired 2-coloured, see A2S material overview
- upholstery made of foam

TURNING SPINDLE STOOL AND HIGH TABLE



MODEL	9377.001	9377.002	9378
Frame upper part powder-coated	■	■	■
Solid wood frame	Oak	Oak	Oak
Height	48-68 cm	72-92 cm	110 cm
Table top Ø			60 cm
Table top finish			Pure white
Weight	7 kg	9 kg	14 kg

OPTIONS

Table top natural oak

■



7940 Plastic stool

PLASTIC STOOL

- stepless seat height adjustment by hand strap from 45-63 cm by safety gas-lift
- rotatable top with integrated support channel on the underside of the seat
- soft seat inlay and base in RAL 7012 basalt grey
- ergonomic sitting thanks to rounded base with anti-slip underside
- available in the colours black, grey-white and red
- plastic recyclable

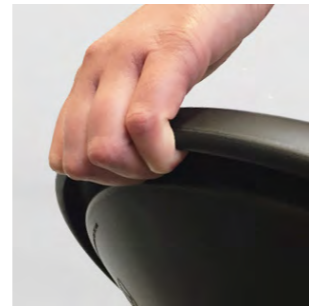

integrated support channel



soft seat inlay



special base shape with rounded, non-slip standing surface



7940 The flexible stool is versatile in the classroom



stepless seat height adjustment by hand strap from 45-63 cm by safety gas-lift



ergonomic sitting due to rounded base

PLASTIC STOOL



MODEL	7940
Frame	Gas-lift
Head office	Plastic
Size	6-7
Height	45-63 cm
Seat	Ø 33 cm
Weight	4.3 kg



3639 CHANGE high table 2-seater
7897 CHANGE bench 2-seater
7898 CHANGE bench 1-seater

CHANGE | BENCHES AND HIGH TABLE 7896 | BAR STOOL

- filigree lounge furniture for comfortable sitting
- closed skid as subconstruction, made of chrome-plated, micro-alloyed round steel, each with plastic floor protectors, optional with felt floor protectors
- with stable cross braces as supports for the feet
- CHANGE series seat and table top made of PAGHOLZ®, available in PAGHOLZ® Natural 010 or Colour Wood Coffee 210, colours see A2S material overview
- bar stool seat in CPL black coated



Resistant to chemicals



Scratch- and wear-resistant



Shock- and break-proof







7896 CHANGE Bar stool 1-seater

3639 CHANGE high table 2-seater
7897 CHANGE bench 2-seater
7898 CHANGE bench 1-seater



CHANGE BENCHES AND HIGH TABLE

				
MODEL	7897	7898	3639	7896
Description	Bench 2-seater	Bench 1-seater	High table 130 x 65 cm	Bar stool 1-seater
Chrome-plated frame	■	■	■	■
Seat/table top	PAGHOLZ®	PAGHOLZ®	PAGHOLZ®	Beech plywood
Height	88 cm	81 cm/88 cm	118 cm	83 cm
Weight	14 kg	10 kg	18 kg	7 kg

OPTIONS

Felt floor protectors	■	■	■	■
Stack transporter 3460 *				max. 5 bar stools

*info p. 34-35



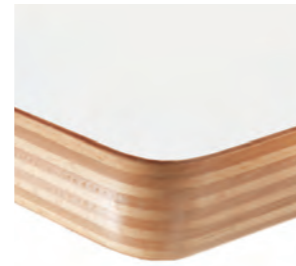

Solid beech multiplex edge crowned natural varnished



9445.160 Bench with castors

BENCHES



- seats made of solid beech multiplex or beech wood
- environmentally friendly sealed with water-based lacquer
- beech multiplex seat with HPL coating available in many finishes, see A2S material overview
- powder-coated frame in various colours, see A2S material overview
- stackable bench optional with castors ideal for flexible use



9459.004 Bench solid wood with middle bar



9440 Changing room bench double-sided



9430 Changing room bench one-sided



9445.100 Bench, stackable. Retrofittable with castors at any time



Stackable 5 pieces



With 2 castors on one side for easy changeover

BENCHES



MODEL	9459.004	9445.100	9430	9440	9450
Frame			one-sided	double-sided	
Powder-coated frame	Solid wood	■	■	■	■
Seat solid beech wood	Multiplex board	Multiplex board	■	■	■
Backrest			■	■	
Size/seat height	38 cm	3/4/5/6	42 cm	42 cm	42 cm
Lengths	1.20 m	1 m/1.20 m/1.60 m/1.80 m/2 m	1 m/2 m/3 m/4 m	1 m/2 m/3 m/4 m	1 m/2 m/3 m/4 m
Weight	9 kg	8.54 kg	30 kg	40 kg	20 kg
Stackability		5 pieces			

OPTIONS

Chrome-plated frame	■
Castors can be retrofitted	■
Felt floor protectors	■
Shoe tray	9460
With rear crossbar	9469.004

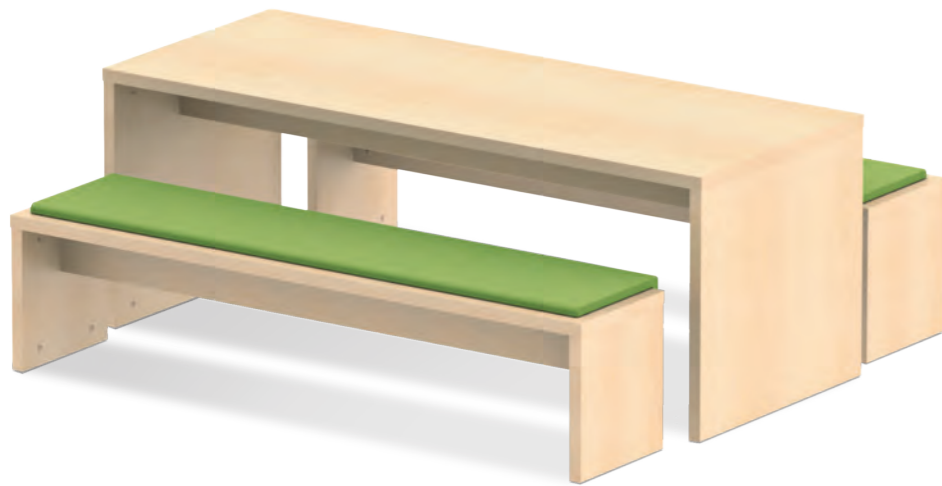

3101.208 SOLID table
3103.194 SOLID bench
3104.194 Bench upholstery



Optional with integrated sockets and lateral cable outlet



Integrated cable channel under the table top

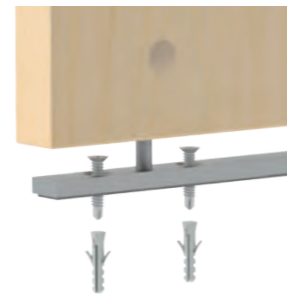

Optional with floor mounting

31 SERIES | SOLID BENCHES AND TABLES







- made of 38 mm thick 3-layer finish board B1 according to DIN 4102
- 2 mm plastic edge in table top colour
- available in three heights
- completely demountable system
- floor protectors with level compensation
- optional with floor mounting and integrated sockets incl. cable duct
- version with privacy screen available for high tables
- use: All-day rooms, assembly hall, cafeteria, canteen, hallway
- possible panel decors: U400 Pure white, D033 Maple, D334 Beech, D4110 Sonoma oak, D5028 Acacia, see A2S material overview
- bench upholstery cover available with fabric groups 1-4, see A2S material overview





3101.208 SOLID table equipped with central sockets
7899 Bar stool



3112.208 SOLID table with privacy screen equipped with sockets at the front and lateral cable outlets

31 SERIES SOLID TABLES	WITH PANEL	WITH FOOTREST	WITH FOOTREST AND PANEL
			
HEIGHT	64 CM AND 75 CM	75 CM	110 CM
Plate dimensions 120 x 80 cm	3101.128	3111.128	3102.128
Plate dimensions 140 x 80 cm	3101.148	3111.148	3102.148
Plate dimensions 160 x 80 cm	3101.168	3111.168	3102.168
Plate dimensions 180 x 80 cm	3101.188	3111.188	3102.188
Plate dimensions 200 x 80 cm	3101.208	3111.208	3102.208
Footrest		■	■
Privacy screen		■	■
OPTIONS			
Cable outlet	■	■	■
Floor mounting	■	■	■
2-way power socket with USB charger	■*	■**	■*
2-way socket with network	■*	■**	■*

* 1 x central up to W 140 cm, 1 x left and 1 x right from W 160 cm
 ** 1 x center, 1 x left, 1 x right or both sides possible for all sizes

31 SERIES SOLID BENCHES	WITH FOOTREST	BENCH UPHOLSTERY	
			
SEAT HEIGHT	38 CM AND 45 CM	78 CM	
Seat area 110 x 38 cm	3103.114	3105.114	3104.114
Seat area 130 x 38 cm	3103.134	3105.134	3104.134
Seat area 150 x 38 cm	3103.154	3105.154	3104.154
Seat area 170 x 38 cm	3103.174	3105.174	3104.174
Seat area 190 x 38 cm	3103.194	3105.194	3104.194
OPTIONS			
Floor mounting	■	■	

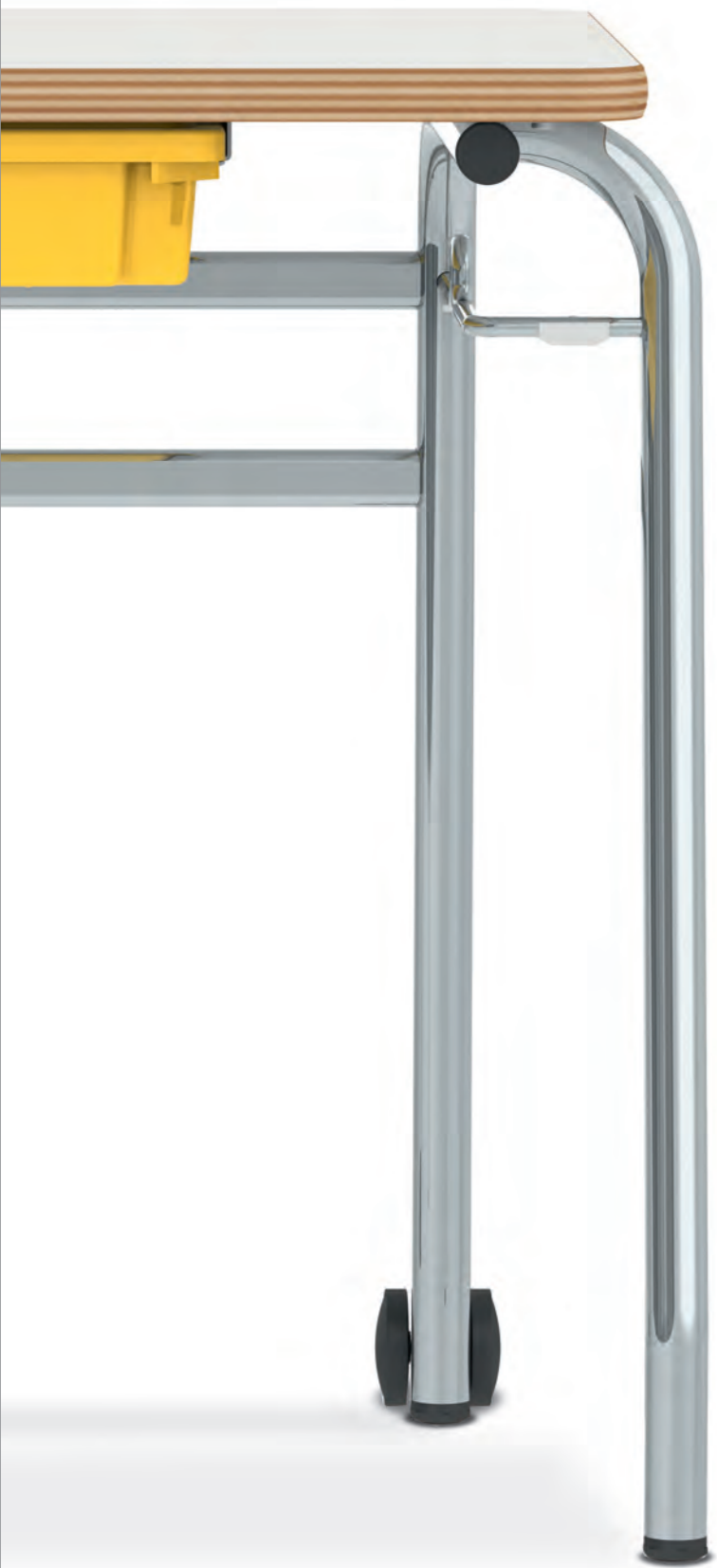

A2S TABLE SERIES



Classroom tables 46 48 50 52 54 56



Height-adjustable tables 56 58 60 61 62 64 66



Teacher's desks 66 68 68 68 68



Specialist room tables Multi-functional tables 70 71 72



Folding tables Lectern Tables with plate base 74 76 78 80 81 82



Metal table systems Wooden tables Containers 84 88 92 98 98 100

Other table sizes, tabletop materials and all options for the tables shown can be found on the pages indicated. You will find our selection of colours, fabrics, finishes and materials in our A2S material overview.



7280 Four-legged classroom table with WOODMARK table top, Tidy Box and 2 castors optional



Easy to stack from the front also with book storage or Tidy Box



With piggyback equipment to prevent the table top from sliding down or scratching when tables are stacked



Optional with stable castors for easy movement in flexible teaching

7280 SERIES CLASSROOM TABLES



- due to the unique asymmetrical frame, the tables are stackable and can be placed side by side without joints
- sturdy, yet lightweight round tube steel frame, scratch-resistant powder-coated or chrome-plated
- available in frame size 2-7
- working surfaces with multi-layer melamine resin coating, thus scratch-resistant, shock-proof and glare-free
- as standard we deliver the table with a 3 mm plastic edge in the colour of the top, see A2S material overview
- other possible board designs: Edge beech concealed edge band crowned, ASSODUR®-Multiplex, WOODMARK or 12 mm compact board, colour selection see A2S material overview
- optional with 2 castors on the long side, mobile and therefore flexibly adjustable



7280 Four-legged classroom table with WOODMARK table top
7416.045 Footrest chair FLEX with comfortable one-hand operation of the footrest - learning at eye level



Up to 4 tables stackable



7280.005 Four-legged classroom table 2-seater with WOODMARK table top, chrome frame, with Tidy Boxes

7280 SERIES | CLASSROOM TABLES



MODEL	7280	7280	7280.002	7280.005	7280.008
Powder-coated frame	1-seater	1-seater	1-seater	2-seater	2-seater
Size	2-7	2-7	2-7	2-7	2-7
Plate dimensions W x D	70 x 50 cm	70 x 55 cm	75 x 65 cm	130 x 50/55 cm	130 x 65 cm
Weight · size 6	14.5 kg	15 kg	16.5 kg	21 kg	25 kg
Stackability	4 pieces	4 pieces	4 pieces	4 pieces	4 pieces
Bag hook	on both sides	on both sides	on both sides	on both sides	on both sides

OPTIONS

Chrome-plated frame	■	■	■	■	■
Felt floor protectors	■	■	■	■	■
2 castors on the long side*	■	■	■	- / ■	■
Book storage basket zinc-plated	■	■	■	■	■
Chair suspension	■	■	■	■	■
Guide rails with Tidy Box A4	■	■	■	■	■

*only available in combination with felt floor protectors



7530 Classroom table 1-seater, optional with chair suspension



Chair suspension under the table top optional



Easy side entry, ideal for small rooms



A2S floor protectors with kick plate protect the floor and table feet from scratches and are easy to change

75 SERIES CLASSROOM TABLES



- absolutely robust, torsion-free oval tube steel frame (50 x 30 x 2 mm) scratch-resistant powder-coated with board support, for extra large boards with double web
- easy side entry, ideal for small rooms
- available in frame size 2-7
- working surfaces with multi-layer melamine resin coating, thus scratch-resistant, shock-proof and glare-free
- as standard we deliver the table with a 3 mm plastic edge in the colour of the table top, see A2S material overview
- other possible board designs: Edge beech concealed edge band crowned, ASSODUR®-Multiplex, WOODMARK or 12 mm compact board, colour selection see A2S material overview



7536 Classroom table, 2-seater with double column and 12 mm compact board
7854 FLEX C-shape chair

75 SERIES | CLASSROOM TABLES



MODEL	7530	7530	7532	7534	7534	7536	7538
Powder-coated frame	1-seater	1-seater	1-seater	2-seater	2-seater	2-seater	2-seater
Size	2-7	2-7	2-7	2-7	2-7	2-7	2-7
Plate dimensions W x D	70 x 50 cm	70 x 55 cm	75 x 65 cm	130 x 50 cm	130 x 55 cm	130 x 65 cm	150 x 65 cm
Weight · size 6	17 kg	17.5 kg	19 kg	23 kg	24 kg	26 kg	28 kg
Bag hook	left or right	left or right	left or right	on both sides	on both sides	on both sides	on both sides

OPTIONS

WOODMARK board	■	■	■	■	■	■	■
Book storage basket zinc-plated	■	■	■	■	■	■	■
Chair suspension	■	■	■	■	■	■	■
Felt floor protectors with kick plate	■	■	■	■	■	■	■
Guide rails with Tidy Box A4	7530003	7530003	■	■	■	■	■



9530 Classroom table 1-seater with Tidy Box A4



In the Tidy Box, even small utensils such as erasers or rulers are in good hands.



The Tidy Box with exchangeable name badge is available in 2 sizes and in 5 colours, see A2S material overview

95 SERIES | CLASSROOM TABLES



- robust, torsion-free double-column construction (40 x 20 x 1.5 mm and 50 x 30 x 2 mm) scratch-resistant powder-coated, with board support for 2-seater, selection of steel colours see A2S material overview
- available in frame size 2-7
- working surfaces with multi-layer melamine resin coating, thus scratch-resistant, shock-proof and glare-free
- as standard we deliver the table with a 3 mm plastic edge in the colour of the top, see A2S material overview
- other possible board designs: Edge beech concealed edge band crowned, ASSODUR®, Multiplex, WOODMARK or 12 mm compact board, colour selection see A2S material overview



9534 Classroom table 2-seater with chair suspensions in WOODMARK maple finish
7100 WOODMARK sliding chair in maple finish

95 SERIES | CLASSROOM TABLES



MODEL	9530	9530	9532	9534	9534	9536	9538
Powder-coated frame	1-seater	1-seater	1-seater	2-seater	2-seater	2-seater	2-seater
Size	2-7	2-7	2-7	2-7	2-7	2-7	2-7
Plate dimensions W x D	70 x 50 cm	70 x 55 cm	75 x 65 cm	130 x 50 cm	130 x 55 cm	130 x 65 cm	150 x 65 cm
Weight · size 6	13 kg	13.5 kg	15 kg	18.5 kg	19.5 kg	20 kg	21.5 kg
Bag hook	on both sides	on both sides	on both sides	on both sides	on both sides	on both sides	on both sides

OPTIONS							
WOODMARK board	■	■	■	■	■	■	■
Book storage basket zinc-plated	■	■	■	■	■	■	■
Chair suspension	■	■	■	■	■	■	■
Guide rails with small Tidy Box A4	■	■	■	■	■	■	■
Felt floor protectors	■	■	■	■	■	■	■

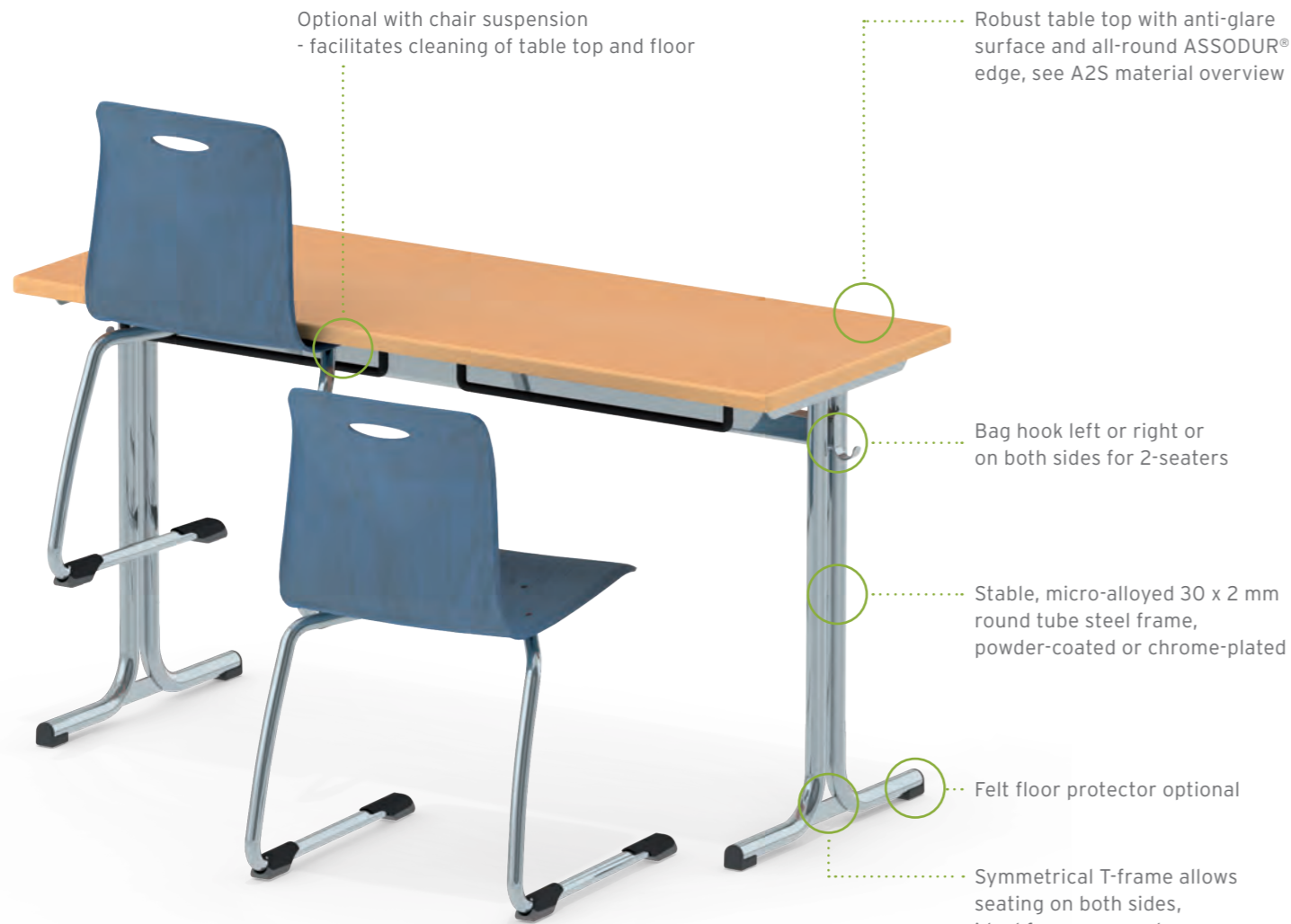

7220 Classroom table 2-seater
optional with chair suspension
7307 PAGHOLZ® C-shape sliding chair



7210 1-seater with WOODMARK board
7853 FLEX Z-shape

72/73 SERIES | CLASSROOM TABLES



- absolutely robust round tube steel frame (30 x 2 mm), scratch-resistant powder-coated or chrome-plated, with board support for 2-seater
- available in frame size 2-7
- working surfaces with multi-layer melamine resin coating, thus scratch-resistant, shock-proof and glare-free
- as standard we deliver the table with a 3 mm plastic edge in the colour of the top, see A2S material overview
- other possible board designs: Edge beech concealed edge band crowned, ASSODUR®, Multiplex, WOODMARK or 12 mm compact board, colour selection see A2S material overview



72/73 SERIES | CLASSROOM TABLES



MODEL	7210	7210	7310	7220	7220	7320	7340
Powder-coated frame	1-seater	1-seater	1-seater	2-seater	2-seater	2-seater	2-seater
Size	2-7	2-7	2-7	2-7	2-7	2-7	2-7
Plate dimensions W x D	70 x 50 cm	70 x 55 cm	75 x 65 cm	130 x 50 cm	130 x 55 cm	130 x 65 cm	150 x 65 cm
Weight · size 6	13.3 kg	13.9 kg	16.2 kg	15 kg	16 kg	18 kg	20 kg
Bag hook	left or right	left or right	left or right	on both sides	on both sides	on both sides	on both sides

OPTIONS

WOODMARK board	■	■	■	■	■	■	■
Book storage basket zinc-plated*	■	■	■	■	■	■	■
Chair suspension*	■	■	■	■	■	■	■
Felt floor protectors	■	■	■	■	■	■	■

*either book storage basket or chair suspension



7010 Solid wood sliding table, 1-seater with bag hook
7000 Solid wood sliding table



7030 Wooden sliding table, 2-seater, solid wood, environmentally friendly protected with water-based lacquer

70 SERIES | CLASSROOM TABLES

- solid beech frame from sustainable forestry, environmentally friendly varnished with water-based lacquer
- extra stable with continuously mortised and glued connections
- available in frame size 2-7
- working surfaces with multi-layer melamine resin coating, thus scratch-resistant, shock-proof and glare-free
- as standard we deliver the table with a 3 mm plastic edge in the colour of the top, see A2S material overview
- other possible board designs: Edge beech concealed edge band crowned, ASSODUR®, Multiplex, WOODMARK or 12 mm compact board, colour selection see A2S material overview
- optionally with one bag hook per seat, position left or right for 1-seater tables free selectable

70 SERIES | CLASSROOM TABLES



MODEL	7010	7010	7030	7030
Frame natural beech, varnished	1-seater	1-seater	2-seater	2-seater
Size	2-7	2-7	2-7	2-7
Plate dimensions W x D	70 x 50 cm	70 x 55 cm	130 x 50 cm	130 x 55 cm
Weight · size 6	11 kg	11.5 kg	18 kg	20 kg

OPTIONS

Book storage basket zinc-plated	■	■	■	■
Felt floor protectors	■	■	■	■
Bag hook	■	■	■	■



8564 Classroom table 2-seater with WOODMARK board, optional with chair suspension
7811 PAGHOLZ® C-shape with handle hole



Easy cleaning of table top and floor due to optional chair suspension



856 Series
 can be seated from both sides - ideal for group work



A2S floor protectors with continuous step protection protect floor and table feet from scratching

856 SERIES | CLASSROOM TABLES AND 858 SERIES | HEIGHT-ADJUSTABLE CLASSROOM TABLES



- robust, torsion-free oval column construction (50 x 30 x 2 mm), scratch-resistant powder-coated, with crossbar (50 x 20 x 2 mm) and board support for 2-seater
- 856 Series available in fixed frame sizes 2-7
- 858 Series with height adjustment by locking in colour-coded steps
- incl. A2S floor protectors with continuous step protection, protect the floor as well as the table feet from scratching
- working surfaces with multi-layer melamine resin coating, thus scratch-resistant, shock-proof and glare-free
- as standard we deliver the table with a 3 mm plastic edge in the colour of the top, see A2S material overview
- other possible board designs: Edge beech concealed edge band crowned, ASSODUR®, Multiplex, WOODMARK or 12 mm compact board, colour selection see A2S material overview



8582.135 Height-adjustable table, 2-seater with WOODMARK tabletop and optional book storage baskets



Optional with book storage basket







including one bag hook per seat



858er Serie
 with height adjustment by locking in colour-coded steps

856 SERIES | CLASSROOM TABLES

					
MODEL	8560	8562	8564	8566	8567
Powder-coated frame	1-seater	1-seater	2-seater	2-seater	2-seater
Size	2-7	2-7	2-7	2-7	2-7
Plate dimensions W x D	70 x 50/55 cm	75 x 65 cm	130 x 50/55 cm	130 x 65 cm	150 x 65 cm
Weight · size 6	12.5 kg	14 kg	19 kg/20 kg	20 kg	22 kg
Height-adjustable · size 2-7	8582.075	8582.076	8582.135	8582.136	
Bag hook	left or right	left or right	on both sides	on both sides	on both sides

OPTIONS

WOODMARK board	■	■	■	■	
Book storage basket zinc-plated*	■	■	■	■	■
Chair suspension*	■	■	■	■	■
Felt floor protectors	■	■	■	■	■

*either book storage basket or chair suspension



Solid beech multiplex edge crowned natural varnished

7750 Classroom table 1-seater height-adjustable
Multiplex top, edges natural varnished, optional with chair suspension
7130/7132 WOODMARK sliding chair height-adjustable in sizes 3-5/5-7



Multiple height adjustment, in sizes 2-5 or 5-7, with coloured size labelings

7755 Classroom table 2-seater height-adjustable with WOODMARK board, optional with Tidy Boxes A4



Multiple height adjustments with allen key

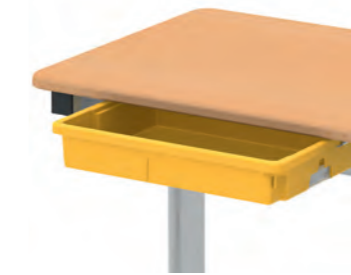

Tidy Boxes create order and more space on the work surface



A2S floor protectors with kick plate protect the floor and table feet from scratches and are easy to change





77 SERIES HEIGHT-ADJUSTABLE CLASSROOM TABLES



- robust metal frame, scratch-resistant due to powder coating, selection of colours see A2S material overview
- easy locking by grid height adjustment with snap lock and safety shut-off by Allen screw
- available in the 2 frame sizes 2-5 and 5-7
- incl. bag hook on the right or on both sides for 2-seater
- working surfaces with multi-layer melamine resin coating, therefore scratch-resistant, shock-proof and glare-free
- as standard we deliver the table with a 3 mm plastic edge in the colour of the top, see A2S material overview
- other possible board designs: Edge beech concealed edge band crowned, ASSODUR®, Multiplex, WOODMARK or 12 mm compact board, colour selection see A2S material overview



77 SERIES | HEIGHT-ADJUSTABLE CLASSROOM TABLES

				
MODEL	7750	7760	7755	7765
Powder-coated frame	1-seater	1-seater	2-seater	2-seater
Size	2-5/5-7	2-5/5-7	2-5/5-7	2-5/5-7
Height adjustability	54-70/70-82 cm	54-70/70-82 cm	54-70/70-82 cm	54-70/70-82 cm
Plate dimensions W x D	70 x 55 cm	75 x 65 cm	130 x 55 cm	130 x 65 cm
Weight	18 kg/18.5 kg	19.5 kg/20.5 kg	22.5 kg/23.5 kg	24.5 kg/25.5 kg
Bag hook	left or right	left or right	on both sides	on both sides
OPTIONS				
Book storage basket zinc-plated	■	■	■	■
Chair suspension	■	■	■	■
Felt floor protector with kick plate	■	■	■	■
Guide rails with Tidy Box A4	■	■	■	■



7692 Classroom table 1-seater height-adjustable, with fixed table top
8389 PAGHOLZ® gas lift swivel stool

Feet with scratch protection and adjusting screws to level uneven floors

769 SERIES HEIGHT-ADJUSTABLE CLASSROOM TABLES



- robust metal frame, scratch-resistant due to powder coating, selection of colours see A2S material overview
- adjustable from size 3-7
- incl. A2S floor protectors with kick plate, protect the floor and table feet from scratches and are easy to change
- working surfaces with multi-layer melamine resin coating, thus scratch-resistant, shock-proof and glare-free
- as standard we deliver the table with a 3 mm plastic edge in the colour of the table top, see A2S material overview
- other possible board designs: Edge beech concealed edge band crowned, ASSODUR®, Multiplex, WOODMARK or 12 mm compact board, colour selection see A2S material overview



7602 Standing/sitting table 1-seater including pencil tray and book stop

760 SERIES | STANDING/SITTING TABLES



- robust metal frame, scratch resistant due to powder coating, selection of colours see A2S material overview
- adjustable in height
- incl. A2S floor protectors with step protection, protect the floor as well as the table feet from scratching and are easy to change
- angled tabletop 0.8 mm HPL coated with multi-layer melamine resin coating, scratch and impact resistant as well as glare-free
- infinitely variable inclination of the tabletop from 0°-90° incl. pencil tray at the back and book stop at the front
- by default we deliver the table with a 3 mm plastic edge in panel colour, see A2S material overview
- other possible panel finishes: edge beech glue-in crowned

769 SERIES HEIGHT-ADJUSTABLE CLASSROOM TABLES WITH STRAIGHT BOARD



MODEL	7692	7697
Powder-coated frame	1-seater	2-seater
Size	3-7	3-7
Height adjustability	58-82 cm*	58-82 cm*
Board inclination		
Plate dimensions W x D	75 x 65 cm	130 x 65 cm
Weight · size 6	25 kg	40 kg
Bag hook	left or right	on both sides

760 SERIES STANDING/SITTING TABLES WITH INCLINED TOP



MODEL	7600	7602
Powder-coated frame	1-seater	1-seater
Size	3-7	6
Height adjustability	58-82 cm	76-106 cm
Board inclination	0-90 degrees	0-90 degrees
Plate dimensions W x D	70 x 55 cm	75 x 53 cm
Weight · size 6	23 kg	24 kg
Bag hook		

OPTIONEN

Book storage basket zinc-plated	■	■		
Felt floor protectors with kick plate	■	■	■	■
Removable crank	■	■		

*The crank for height adjustment is fixed as standard, but can also be supplied with a removable crank on request.



1110 Drawing table with storage, optional with book stop



1110 Drawing table with continuously tiltable and height-adjustable table top

1110 | DRAWING TABLE

- robust metal frame, scratch resistant due to powder coating, selection of colours, see A2S material overview
- incl. A2S floor protectors with step protection, protect the floor as well as the table feet from scratches and are easy to change
- tabletop and shelf exclusively in 3-layer decorative panel (E1), 0.8 mm
- glued with 2 mm plastic edge in panel colour, see A2S material overview
- infinitely variable inclination of the table top from 0°-90°, optionally with front book stop bar

1110 | DRAWING TABLE



MODEL	1110
Powder-coated frame	1-seater
Size	6
Height adjustability	76-117 cm
Board inclination	0-90 degrees
Plate dimensions W x D	90 x 60 cm
Weight · size 6	28 kg

OPTIONS

Felt floor protectors with kick plate	■
Book stop	■



ACCESSORIES FOR CLASSROOM TABLES

CHAIR SUSPENSIONS



0200

suitable for chair models
7200/7205/7800/7805
PAGHOLZ® sliding chair



0831

Zinc-plated steel with rubber coating
suitable for chair models
7100 WOODMARK ssliding chair (size 3-7)
7307/7811/7813 PAGHOLZ® C-shape
7819.010/7822 Multiplex C-shape



0837

suitable for chair models
8385 PAGHOLZ® gas lift swivel chair
7854 FLEX C-shape
7873 FLEX gas lift swivel chair
7875 FLEX swivel chair



0881*/0882*

suitable for chair models
7873 FLEX gas lift swivel chair 3D rocker (size 5-7)/
7876 FLEX gas lift swivel chair 3D rocker (size 3-5)

* Only suitable for tables without front frame

BOOK STORAGE BASKET



0303/0304

50 x 8.5 x 20 cm,
zinc-plated

TIDY BOX INCL. RAILS



0886

31 x 7,5 x 43 cm,
in 5 colours

BAG HOOK



0540

galvanized



5580.168 OFFICE desk electrically height adjustable



Self-explanatory control element optional with memory function



Hidden cable management by hinged cable tray



Floor protector with level compensation for easy leveling of uneven floors

OFFICE SERIES MOTORIZED HEIGHT-ADJUSTABLE OFFICE TABLES



- large adjustment range from 62 to 127 cm in height, therefore usable as a worktable and standing table
- stable frame even in standing height
- frame powder-coated in RAL 9006 chrome silver, RAL 9016 white or RAL 9005 black possible
- equipped with floor levellers
- hidden cable management by hinged metal cable tray incl. 6-way socket strip
- self-explanatory control element, optional with memory function
- note: Power supply required
- working surfaces with multi-layer melamine resin coating, therefore scratch-resistant, shock-proof and glare-free, for finishes see A2S material overview
- with a 3 mm plastic edge in board colour, see A2S material overview



5580.168 OFFICE table
9232.800 Rolling container
7873.002 FLEX gas lift swivel chair with elevation and foot ring



5585.208 OFFICE table L-shaped
9335 WAVE gas lift swivel chair

OFFICE SERIES | MOTORIZED HEIGHT-ADJUSTABLE OFFICE TABLES RECTANGULAR

MODEL	5580.128	5580.129	5580.148	5580.149	5580.168	5580.169	5580.188	5580.189	5580.208	5580.209
Frame powder-coated RAL 9006	■	■	■	■	■	■	■	■	■	■
motorized height-adjustability	62-127 cm	62-127 cm	62-127 cm	62-127 cm	62-127 cm	62-127 cm	62-127 cm	62-127 cm	62-127 cm	62-127 cm
Plate dimensions W x D in cm	120 x 80	120 x 90	140 x 80	140 x 90	160 x 80	160 x 90	180 x 80	180 x 90	200 x 80	200 x 90
Weight	43 kg	45 kg	58 kg	66 kg	74 kg	82 kg	76 kg	84 kg	88 kg	96 kg
6-way Schuko power socket with 3 m supply cable	■	■	■	■	■	■	■	■	■	■

OPTIONS

Frame black or white	■	■	■	■	■	■	■	■	■	■
Cable outlet	■	■	■	■	■	■	■	■	■	■
CPU holder 1876.020	■	■	■	■	■	■	■	■	■	■
Front panel	2050.122	2050.122	2050.142	2050.142	2050.162	2050.162	2050.182	2050.182	2050.202	2050.202

OFFICE SERIES | MOTORIZED HEIGHT-ADJUSTABLE OFFICE TABLES L-SHAPE

MODEL	5585.208	5586.208
Variant	left	right
Powder-coated frame	■	■
motorized height-adjustability	62-127 cm	62-127 cm
Plate dimensions W x D in cm	200 x 160/80	200 x 160/80
Weight	86 kg	86 kg
6-way Schuko power socket with 3 m supply cable	■	■

OPTIONS

Frame black or white	■	■
Cable outlet	■	■
CPU holder 1876.020	■	■
Front panel	2050.202	2050.202

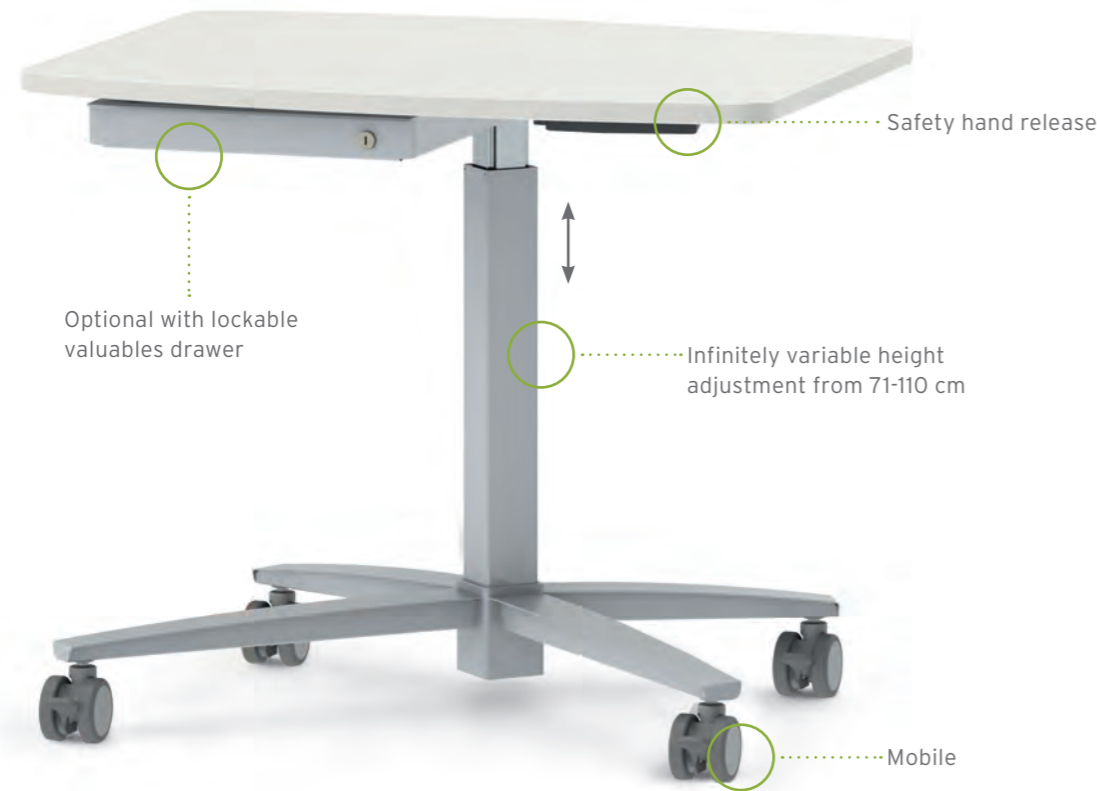

7616.097 Barrel-shaped mono-column table, mobile with lockable valuables drawer

76 SERIES HEIGHT-ADJUSTABLE MONO-COLUMN TABLES



- large adjustment range in height, therefore usable as work and standing table
- triggering of the height adjustment by means of encapsulated Bowden cable and safety hand release, which prevents unintentional release
- heavy-duty, torsion-resistant tubular steel table column
- optional all-steel valuables drawer under the table top
- frame powder-coated in RAL 9006 chrome silver
- optionally available with 12 mm compact board, not with front panel
- possible finish table tops see A2S material overview



7612.076 Rectangular mono-column table with 12 mm compact board, with H-shaped frame, 2 floor protectors with levelling at the front and 2 castors at the back



7614.097 Barrel-shaped mono-column table with H-shaped frame, 2 floor protectors with levelling at the front and 2 castors at the back







7618.080 Circular mono-column table 5-legged base frame with robust easy-running castors



7620.138 Oval mono-column table with perforated sheet metal front panel
7873.002 FLEX gas lift swivel chair with foot ring

76 SERIES | PNEUMATIC HEIGHT-ADJUSTABLE MONO-COLUMN TABLES

BOARD					
MODEL	7612.076	7614.097	7615.138	7616.097	7618.080
Frame powder-coated RAL 9006	■	■	■	■	Polished ALU
Height adjustability	70-110 cm	70-110 cm	71-110 cm	71-110 cm	77-116 cm
Plate dimensions W x D	75 x 65 cm	90 x 70 cm	130 x 80 cm	90 x 70 cm	Ø 80 cm
Weight	19 kg	21.7 kg	31 kg/31.5 kg	19.1 kg	17.6 kg
Castors	■	■	■	■	■

OPTIONS

Lockable valuables drawer	■	■			
Front panel			7620.138*		

*not possible with compact board



7268
Chrome-plated metal frame with two castors and a lockable base cabinet with two drawers

TEACHER'S DESKS



- frames match the classroom tables: made of metal, scratch-resistant powder-coated, or solid wood natural beech varnished with transparent water-based lacquer
- model 7268 mobile with castors (suitable for classroom table model 7280)
- optional with felt floor protectors
- the base units and drawers are lockable as standard
- working surfaces 130 x 65 cm or 150 x 65 cm with additional melamine resin coating, therefore scratch and impact resistant and glare-free
- as standard, we supply the table with a 3 mm plastic edge in the colour of the table top, for colour selection see A2S material overview
- WOODMARK board not possible in size 150 x 65 cm
- other possible board designs: Edge beech concealed edge band crowned, ASSODUR®, Multiplex or WOODMARK board, colour selection see A2S material overview



7573.901 Base unit with storage compartment, with 1-door base unit on the right
Frame 4-legged oval tube



7357.902 Base unit with storage compartment, right base unit with utensil drawer and 3 drawers
Skid frame



7524.901 Base unit with storage compartment, with 1-door base unit and drawer on the left
Frame C-shape oval tube



7059.902 Base unit with storage compartment, left with 1-door base unit, right with utensil drawer and 3 drawers
Frame solid wood beech natural varnished

TEACHER'S DESKS BOARD SIZE 130 X 65 CM



FRAME	7571.901	7572.901/7573.901	7574.901/7575.901	7576.901/7577.901	7268**	7570	7520
4-legged*							
C-shape*	7521.901	7522.901/7523.901	7524.901/7525.901	7526.901/7527.901			
Center column**	7351.901	7352.901/7353.901	7354.901/7355.901	7356.901/7357.901			
Solid beech wood	7051.901	7052.901/7053.901	7054.901/7055.901	7056.901/7057.901			
Substructure		left/right	left/right	left/right	left or right	left or right	left or right
Dimensions W/D/H in cm	130 x 65 x 76	130 x 65 x 76	130 x 65 x 76	130 x 65 x 76	130 x 65 x 76	130 x 65 x 76	130 x 65 x 76
Weight	46.3 kg	54 kg	58 kg	65 kg	54 kg	22 kg	30 kg

*powder-coated **powder-coated; chrome-plated frame optionally available

TEACHER'S DESKS BOARD SIZE 150 X 65 CM



FRAME	7571.902	7572.902/7573.902	7574.902/7575.902	7576.902/7577.902	7578.902	7579.902
4-legged*						
C-shape*	7521.902	7522.902/7523.902	7524.902/7525.902	7526.902/7527.902	7528.902	7529.902
Center column**	7351.902	7352.902/7353.902	7354.902/7355.902	7356.902/7357.902	7358.902	7359.902
Solid beech wood	7051.902	7052.902/7053.902	7054.902/7055.902	7056.902/7057.902	7060.902	7059.902
Cabinet		left/right	left/right	left/right	on both sides	on both sides
Dimensions W/D/H in cm	150 x 65 x 76	150 x 65 x 76	150 x 65 x 76	150 x 65 x 76	150 x 65 x 76	150 x 65 x 76
Weight	51 kg	58 kg	62 kg	69 kg	69 kg	81 kg

*powder-coated **powder-coated; chrome-plated frame optionally available



3930 Series
folding tables in 2 heights: 72 and 75 cm



Robust mechanics,
easy to fold up

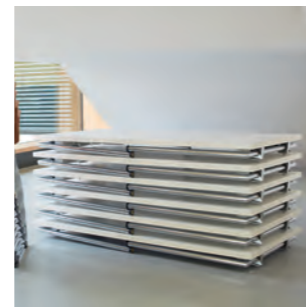

Easily stackable up to 16 tables
thanks to hard rubber buffer



Suitable stacking trolley for safe and
convenient transport of up to 10 tables,
powder-coated RAL 9006 chrome silver

3930 SERIES | FOLDING TABLES



- seating at all four sides
- stable 4-legged folding frame made of round tube (40 x 2 mm), scratch-resistant powder-coated or chrome-plated
- easily stackable up to 16 tables thanks to hard rubber buffer
- equipped with an aluminium design frame (Fig. p. 76), laterally beveled in natural anodised finish
- optional with recessed solid wood frame and rounded corners - conceals the folding mechanism
- plastic floor protectors with level compensation
- working surfaces with multi-layer melamine resin coating, thus scratch-resistant, shock-proof and glare-free
- as standard we deliver the table with a 3 mm plastic edge in the colour of the top,
for finish selection see A2S material overview
- optional with robust ASSODUR®-edge or solid wood edge, concealed edge band crowned and natural lacquered
- glued chipboard from a width of 160 cm with aluminium frame



7536 Classroom table, 2-seater
with double column and 12 mm compact board
7854 FLEX C-shape chair

75 SERIES | CLASSROOM TABLES



MODEL	7530	7530	7532	7534	7534	7536	7538
Powder-coated frame	1-seater	1-seater	1-seater	2-seater	2-seater	2-seater	2-seater
Size	2-7	2-7	2-7	2-7	2-7	2-7	2-7
Plate dimensions W x D	70 x 50 cm	70 x 55 cm	75 x 65 cm	130 x 50 cm	130 x 55 cm	130 x 65 cm	150 x 65 cm
Weight · size 6	17 kg	17.5 kg	19 kg	23 kg	24 kg	26 kg	28 kg
Bag hook	left or right	left or right	left or right	on both sides	on both sides	on both sides	on both sides

OPTIONS

WOODMARK board	■	■	■	■	■	■	■
Book storage basket zinc-plated	■	■	■	■	■	■	■
Chair suspension	■	■	■	■	■	■	■
Felt floor protectors with kick plate	■	■	■	■	■	■	■
Guide rails with Tidy Box A4	7530003	7530003	■	■	■	■	■



3690.088 Folding table 4-legged, ideal as single or double table
3305 PAGHOLZ® 4-legged chair

3690 SERIES | FOLDING TABLES



- folding table in small size
- stable 4-legged folding frame made of round tube (30 x 2 mm) chrome-plated
- 25 mm thick working surfaces with multi-layer melamine resin coating, thus scratch-resistant, shock-proof and glare-free
- as standard we deliver the table with a 3 mm plastic edge in the colour of the top, for finish selection see A2S material overview
- optional with robust ASSODUR®-edge or solid wood edge, concealed and crowned edge band, natural lacquered
- plastic floor protectors with level compensation

3690 SERIES | FOLDING TABLES

MODEL	3690.087	3690.088
Chrome-plated frame	■	■
Height	72 cm	72 cm
Dimensions W x D in cm	80 x 70	80 x 80
Weight	17.9 kg	19.3 kg
ASSODUR® edge	■	■
Stacking trolley	■	■
3899.147 (120 cm)		



7720 Lectern including front book stop

7720 | LECTERN



- 25 mm thick tabletop, slanted, with multilayer melamine resin coating, thus scratch and impact resistant as well as glare-free
- tabletop including book stop strip in front and beech solid wood pen tray in the back
- standard with 3 mm plastic edge in table top colour, decors from price group 1 selectable, see A2S material overview
- center column base: rectangular tube 40/20/2 mm and round tube 50 x 3 mm, powder-coated in RAL 9006 chrome silver
- screen made of perforated sheet metal with square perforation, 1.5 mm thick
- plastic floor protector with integrated step protection and level compensation

7720 | LECTERN



MODEL	7720
Powder-coated frame	■
Height	124 cm
Dimensions W x D in cm	75 x 61
Weight	25 kg

OPTIONS

Felt floor protectors	■
Without book stop	■
Without pencil tray	■



2006.080 Circular table with plate base; stable due to heavy plate base with adjustable feet for level compensation



2005.088 Square table with plate base

200 SERIES | TABLES WITH PLATE BASE



- 25 mm thick working surfaces with multi-layer melamine resin coating, thus scratch-resistant, shock-proof and glare-free
- as standard we deliver the table with a 3 mm plastic edge in the colour of the top, for finish selection see A25 material overview
- round tube column (80 x 2 mm) made of stainless steel
- stable due to the heavy plate base made of micro-alloyed steel/stainless steel satin finish
- plastic floor protectors with level compensation



2006.071 Circular standing table for small meetings and catering



2006.070 With table height 45 cm ideal lounge table



2007.200 Elliptical table with plate base ideal for meetings

200 SERIES	ROUND PLATE BASE TABLE						ELLIPTICAL PLATE BASE TABLE			
	●						●			
MODEL	2006.070	2006.071	2006.080	2006.081	2006.100	2006.120	2007.180	2007.200	2007.220	2007.240
Stainless steel column	■	■	■	■	■	■	■	■	■	■
Height	45/75 cm	111 cm	45/75 cm	111 cm	45/75 cm	45/75 cm	45/75 cm	45/75 cm	45/75 cm	45/75 cm
Dimensions W x D	Ø 70 cm	Ø 70 cm	Ø 80 cm	Ø 80 cm	Ø 100 cm	Ø 120 cm	180 x 110 cm	200 x 120 cm	220 x 120 cm	240 x 130 cm
Disc base	Ø 50 cm	Ø 50 cm	Ø 63 cm	Ø 63 cm	Ø 63 cm	Ø 63 cm	Ø 63 cm	Ø 63 cm	Ø 63 cm	Ø 63 cm
Weight (H 75/111 cm)	27 kg	29 kg	36 kg	38 kg	41 kg	47 kg	81 kg	87 kg	90 kg	96 kg
Use	small rooms, waiting areas, canteen, cafeteria						meeting rooms			

OPTIONS										
Decor price group 2	■	■	■	■	■	■	■	■	■	■
Table top HPL glued	■	■	■	■	■	■	■	■	■	■

200 SERIES	PLATE BASE TABLE SQUARE		PLATE BASE TABLE RECTANGULAR	
	■		■	
MODEL	2005.077	2005.088	2005.127	2005.128
Stainless steel column	■	■	■	■
Height	45/75 cm	45/75 cm	45/75 cm	45/75 cm
Dimensions W x D	70 x 70 cm	80 x 80 cm	120 x 70 cm	120 x 80 cm
Disc base	Ø 63 cm	Ø 63 cm	Ø 50 cm	Ø 50 cm
Weight (H 75 cm)	36 kg	38 kg	55 kg	57 kg
Use	small rooms, waiting areas, canteen, cafeteria		meeting rooms	

OPTIONS				
Decor price group 2	■	■	■	■
Table top HPL glued	■	■	■	■



2010 Hexagonal corner unit combined with two 2001 Rectangular tables

Side and front panels are available in various colours and designs. Ask your A2S area manager.

Office chairs: Info p. 30

Containers: Info p. 98

2000 SERIES DEMOUNTABLE METAL TABLE SYSTEM



- demountable, absolutely robust metal frame, scratch-resistant powder-coated or chrome-plated
- directly coated side panels made of round tube (40 x 2 mm), frames made of square tube (40 x 20 x 2 mm)
- 25 mm thick, directly coated chipboard in a particularly scratch-resistant and shock-proof design
- as standard we deliver the table with a 3 mm plastic edge in the colour of the top, for finish selection see A2S material overview
- different table top sizes and shapes (info p. 86-87)
- rectangular table tops optional with 40 mm corner radius
- optional 10 cm height-adjustable
- many accessories, e.g. CPU holder or cable channels (info p. 95)
- plastic floor protectors with level compensation
- for your individually planned table combination, please contact your A2S area manager
- available in two different table heights: 72 and 75 cm



TABLE COMBINATIONS

Do you manage extensive paper documents which need to be permanently available, do you make a lot of phone calls or have frequent meetings at your workplace? A2S offers the right solution for every work area to you - your A2S area manager will be happy to advise you.

EXAMPLES:



Single workstation as corner combination for smaller rooms

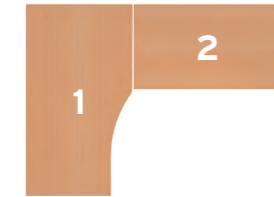

Consisting of
Table 1: 2031/2er 90° extension table
Table 2: 2001s rectangular table



Generous individual workstation with recessed connecting frames for more legroom

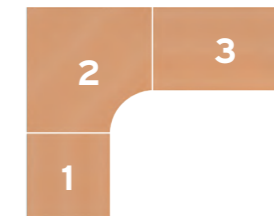

Consisting of
Table 1: 2001s rectangular table
Table 2: 2011s pentagonal table
Table 3: 2001s rectangular table



Two workstations opposite each other with corner unit as visitor's seat or additional storage

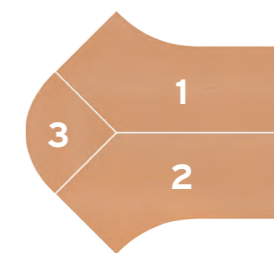

Consisting of
Table 1: 2030/28s 45° extension table right
Table 2: 2029/27s 45° extension table left
Table 3: 2016.080 rounded corner unit or 2017.080 straight corner plate

You will find further table combinations and tabletop variants on the following pages.

INDIVIDUALLY CONFIGURED TABLES

With variable frames, different table top shapes and extensive accessories, such as table attachments or panels, we can plan your workplace to suit your individual needs. Contact your A2S area manager.

	60 CM DEEP			70 CM DEEP				
MODEL	2001.066*	2001.106	2001.126	2001.077	2001.107	2001.127	2001.147	2001.167
Dimensions in cm	60 x 60	100 x 60	120 x 60	70 x 70	100 x 70	120 x 70	140 x 70	160 x 70
Weight H 72/75 cm	11.5/12 kg	17.5/18 kg	20.5/21 kg	14.5/15 kg	19.5/20 kg	24/25 kg	27.5/28.5 kg	31/32 kg

* ATTENTION: Consider the width of the chair frame!

	80 CM DEEP							
MODEL	2001.088	2001.108	2001.128	2001.148	2001.168	2001.188	2001.208	
Dimensions in cm	80 x 80	100 x 80	120 x 80	140 x 80	160 x 80	180 x 80	200 x 80	
Weight H 72/75 cm	17.5/18 kg	22.5/23 kg	26.5/27 kg	28.5/29 kg	32.5/33 kg	37.5/38 kg	39.5/40 kg	

	90 CM DEEP							100 CM DEEP	
MODEL	2001.099	2001.109	2001.129	2001.149	2001.169	2001.189	2001.209	2001.100	2001.200
Dimensions in cm	90 x 90	100 x 90	120 x 90	140 x 90	160 x 90	180 x 90	200 x 90	100 x 100	200 x 100
Weight H 72/75 cm	20.5/21 kg	24.5/25 kg	28.5/29 kg	32.5/33 kg	40.5/41 kg	44.5/45 kg	47.5/48 kg	23.5/24 kg	49.5/50 kg

	90° EXTENSION		90° CORNER EXTENSION		45° EXTENSION		CIRCULAR EXTENSION	
MODEL	2031.188	2031.208	2033.188	2033.208	2029.228	2029.248	2035.228	2035.248
Dimensions in cm	180 x 80 right/ 100 left	200 x 80 right/ 100 left	180 x 80 right/ 80 left	200 x 80 right/ 80 left	221 x 80 right/ 80 left	241 x 80 right/ 80 left	220 x 80 right/ Ø 130 left	240 x 80 right/ Ø 130 left
Plan dimensions W x D in cm	180 x 100	200 x 100	180 x 130	200 x 130	221 x 113	241 x 113	220 x 130	240 x 130
Weight H 72/75 cm	44.5/45 kg	47.5/48 kg	39.5/40 kg	43.5/44 kg	51.5/52 kg	55.5/56 kg	59.5/60 kg	62.5/63 kg
Variant on the right	2032.188	2032.208	2034.188	2034.208	2030.228	2030.248	2036.228	2036.248

OPTIONS
Chrome-plated frame
Table height optional 72 or 75 cm
Height adjustment 10 cm
Round cable outlet
Grille cable channel
CPU holder
Felt floor protectors
Front and side panel, 33 cm high



	PENTAGON EXTENSION				HEXAGON EXTENSION			
MODEL	2009.127	2009.128	2011.127	2011.128	2010.127	2010.148	2012.127	2012.148
Dimensions in cm	120 x 120	120 x 120	120 x 120	120 x 120	120 x 120	137 x 137	120 x 120	137 x 137
Plan dimensions W x D in cm					120 x 120	137 x 137	120 x 120	137 x 137
Fitting dim. in cm	70 each	80 each	70 each	80 each	70 each	80 each	70 each	80 each
Seat width in cm	71	57			70	80		
Segment width in cm			71	57			70	80
Weight H 72/75 cm	37.5/38 kg	37.5/38 kg	37.5/38 kg	37.5/38 kg	37.5/38 kg	45.5/46 kg	37.5/38 kg	45.5/46 kg

	90° CORNER EXTENSION							
MODEL	2014.070	2014.080	2014.090	2016.080*	2015.070	2015.080	2015.090	2017.080
Fitting dim. in cm	70	80	90	80	70	80	90	80
Radius in cm	60	70	80	70				
Weight	12 kg	15 kg	19 kg	15 kg	9.5 kg	11.5 kg	14.5 kg	11.5 kg

*exclusively for position combinations with 45° extension tables

	SEMI-OVAL 80 CM EXTENSION				
MODEL	2013.128	2013.148	2013.168	2013.188	2013.208
Dimensions in cm	120 x 80	140 x 80	160 x 80	180 x 80	200 x 80
Weight H 72/75 cm	32.5/33 kg	35.5/36 kg	38.5/39 kg	41.5/42 kg	44.5/45 kg

OPTIONS SERIES	PENTAGON	HEXAGON	90° CORNER EXTENSION	SEMI-OVAL 80 CM
Chrome-plated frame	■	■		■
Table height optional 72 or 75 cm	■	■		■
Table top with 40 mm corner radius	■	■	■	
Height adjustment 10 cm	■	■		■
Round cable outlet	■	■	■	
Grille cable channel	■	■	■	
Felt floor protectors	■	■		■
Front and side panel, 33 cm high	■	■	■	■

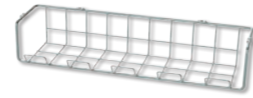

Grille cable channel as accessory for the organisation of cables

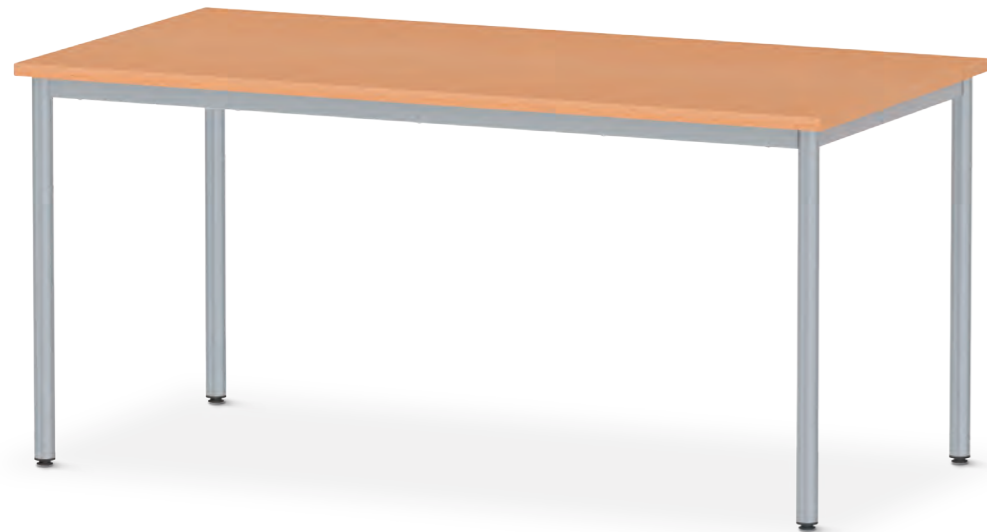

Table top optional with cable outlet



Fixed castor for retrofitting on the transverse or longitudinal side of the tables

Further information on accessories on page 95



1001.168 4-legged table with welded frame

1000 SERIES | WELDED METAL TABLE SYSTEM

- welded, absolutely robust metal frame, scratch-resistant powder-coated or chrome-plated
- side parts made of round tube (40 x 2 mm), frames made of square tube (40 x 20 x 2 mm)
- plastic floor protectors with level compensation
- optional with castors
- many different table top sizes and shapes
- 25 mm thick finish board in a particularly scratch-resistant and shock-proof design
- as standard we deliver the table with a 3 mm plastic edge in the colour of the top, for finish selection see A2S material overview
- see further possible table top designs in ASSODUR® or 12 mm compact board under OPTIONS, colour selection see A2S material overview
- many accessories, e.g. various table attachments and panels, please contact your A2S area manager
- available with frame sizes 3-7 according to DIN ISO 5970 and table heights 72 and 75 cm



TABLE COMBINATIONS WITH 90° TRIANGULAR TABLES

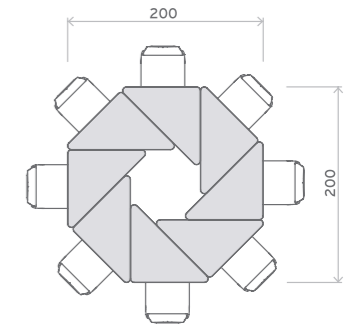
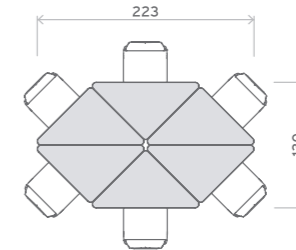
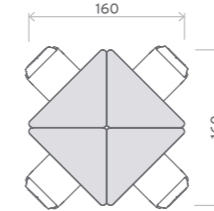

Group work 4 6 8

	50 CM DEEP	55 CM DEEP	60 CM DEEP	65 CM DEEP	70 CM DEEP
MODEL	1001.135*	1001.401*	1001.403*	1001.066*	1001.126*
Dimensions in cm	130 x 50	70 x 55	130 x 55	60 x 60	120 x 60
Weight · Size 6	22 kg	13 kg	23 kg	13 kg	22 kg

*ATTENTION: Consider the width of the chair frame!

	80 CM DEEP	SEMICIRCLE
MODEL	1001.088	1001.128
Dimensions in cm	80 x 80	120 x 80
Weight · Size 6	21 kg	28.5 kg

*ATTENTION: Consider the width of the chair frame!

	60° TRAPEZOID	67.5° TRAPEZOID	90° TRIANGLE
MODEL	1004.126*	1004.302	1004.147
Dimensions in cm	120 x 60 x 60	130 x 65 x 65	140 x 70 x 70
Weight · Size 6	18 kg	20 kg	22 kg

*ATTENTION: Consider the width of the chair frame!

OPTIONS SERIES	RECTANGLE	SEMICIRCLE	60° TRAPEZOID	67.5° TRAPEZOID	90° TRIANGLE
Chrome-plated frame	■	■	■	■	■
Glued	■	■	■	■	■
Compact board 12 mm	■	■	■	■	■
ASSODUR® edge	■	■	■	■	■
Table top with 40 mm corner radius	■	■	■	■	including*
Round cable outlet	■				
Grille cable channel	■				
Felt floor protectors	■	■	■	■	■
Teflon floor protectors	■	■	■	■	■
2 fixed castors for longitudinal or transverse side	■	■	■	■	**
Tidy Box					■

*only available with 40 mm corner radius

** 1 fixed castor on the rear table leg



1016.126 S-shaped table rectangle



1016.066 S-shaped table rectangle with chrome-plated frame and 2 castors
7853 FLEX with the worldwide patented Z-shaped frame



1016.147 S-shaped table rectangle with 7100 WOODMARK sliding chair with C-shape frame

S-SHAPED TABLES:

Countless variable table combinations for all purposes can be "put together" from the numerous table top shapes and sizes.



"S-SHAPE" TABLES	RECTANGLE					60° TRAPEZOID
MODEL	1016.066*	1016.126	1016.077	1016.147	1018.147	
Dimensions W x D in cm	60 x 60	120 x 60	70 x 70	140 x 70	140 x 70 x 70	
Weight · Size 6	13 kg	22 kg	15 kg	28 kg	26 kg	
Info	Corner radius: 40 mm					Corner radius: 40 mm
ASSODUR® edge				■	■	

*ATTENTION: Consider the width of the chair frame!

"S-SHAPE" TABLES	SEMICIRCLE	60° TRIANGLE
MODEL	1019.147	1017.077
Dimensions W x D in cm	140 x 70	70 x 70 x 70
Weight · Size 6	23 kg	13 kg
Info	Corner radius: 40 mm	Corner radius: 40 mm

OPTIONS | SERIES S-SHAPED TABLES

- Chrome-plated frame
- Glued
- Felt floor protectors
- Teflon floor protectors
- 2 fixed castors for longitudinal or transverse side

TABLE COMBINATIONS WITH S-SHAPED TABLES

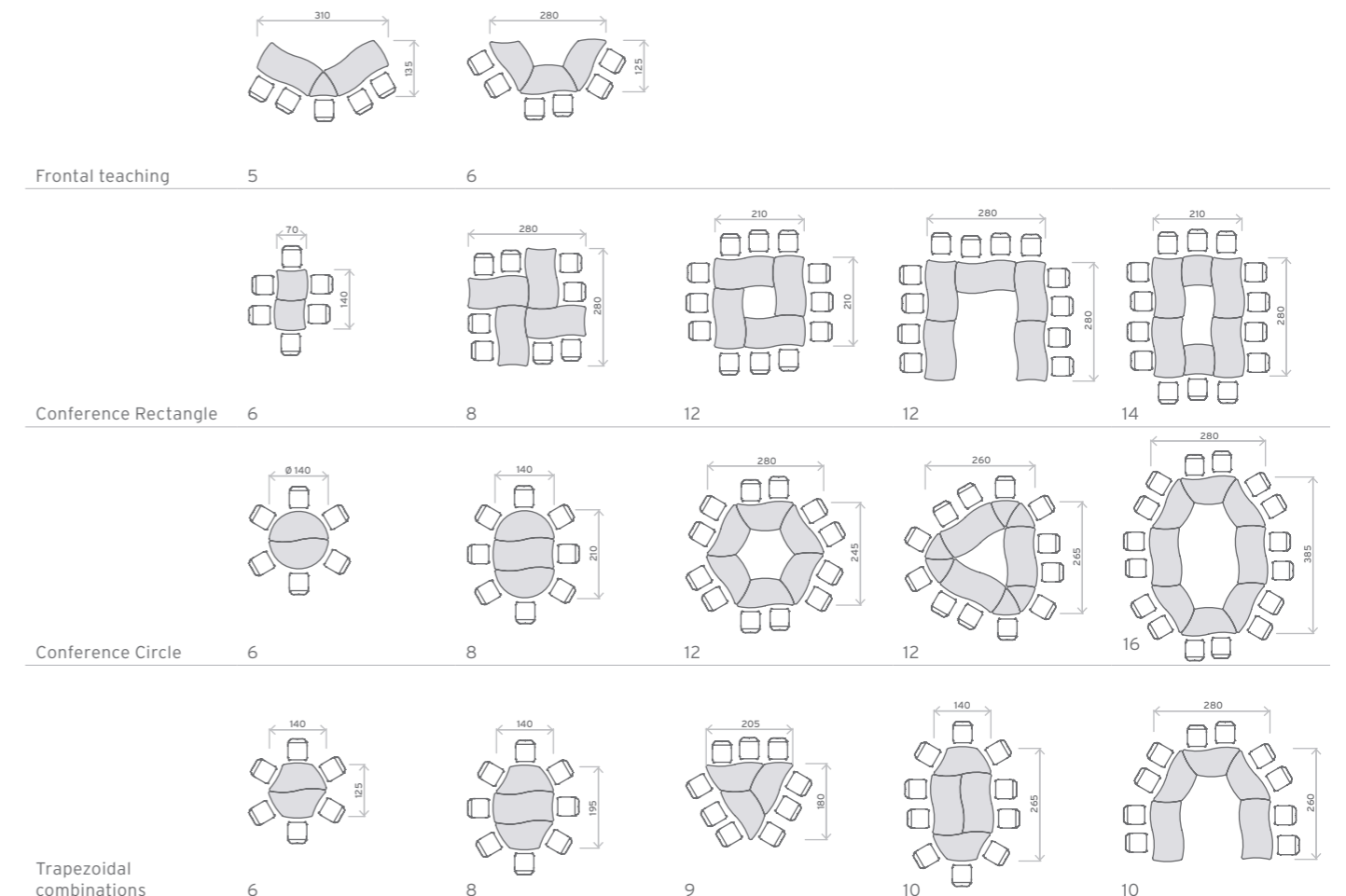



1015.165 Cloud group table
Standing table with shelf

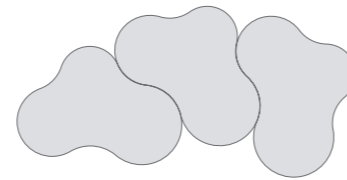

Example combination



1015.165 Cloud group table



The Cloud tables visually soften learning and recreation rooms for a relaxing atmosphere

1015 SERIES | CLOUD GROUP TABLES



- welded, absolutely robust metal frame, scratch-resistant powder-coated
- side parts made of round tube (40 x 2 mm), frames made of square tube (40 x 20 x 2 mm)
- plastic floor protectors with level compensation
- Amoeba-shaped table top allows many combination possibilities due to different outer and inner radii
- 25 mm thick finish board in a particularly scratch-resistant and shock-proof design
- as standard we deliver the table with a 3 mm plastic edge in the colour of the top, for finish selection see A2S material overview
- Standing table with 19 mm thick shelf, shelf height 85 cm, especially scratch and impact resistant design with 2 mm plastic edge in table top colour, for finish selection see A2S material overview



1015 SERIES | CLOUD GROUP TABLES



MODEL	1015.165	1014.165
Powder-coated frame	■	■
Size	2-7	
Height in cm	76	110
Dimensions W x D in cm	165 x 114	165 x 114 cm
Weight (76/110 cm)	42.3 kg	61.3 kg

OPTIONS

Chrome-plated frame	■	■
Felt floor protectors	■	■
Teflon floor protectors	■	■



1026.077 Linking and stacking table with protruding legs on the longitudinal side



optional bag hook



gapless connection



up to 4 tables stackable

1026 SERIES | LINKING AND STACKING TABLES

- welded, absolutely robust metal frame, scratch-resistant powder-coated
- side parts made of round tube (40 x 2 mm), frames made of square tube (40 x 20 x 2 mm)
- plastic floor protectors with level compensation
- 25 mm thick finish board in a particularly scratch-resistant and shock-proof design
- as standard we deliver the table with a 3 mm plastic edge in the colour of the top, for finish selection see A2S material overview



1026.075 Linking and stacking table gapless connection despite protruding legs



1026.147 Easily stackable without dismantling to save space: Simply lift a few centimetres and slide it over the lower table; the welded frame makes them particularly stable.

LINKING AND STACKING TABLES	PROTRUDING LEGS ON LONGITUDINAL SIDE							
	1026.075	1026.076	1026.077	1026.088	1026.135	1026.136	1026.147	1026.168
MODEL	1026.075	1026.076	1026.077	1026.088	1026.135	1026.136	1026.147	1026.168
Dimensions W x D in cm	70 x 55	75 x 65	70 x 70	80 x 80	130 x 55	130 x 65	140 x 70	160 x 80
Weight · Size 6	15 kg	18 kg	18 kg	21 kg	23.3 kg	25.7 kg	29 kg	35 kg
Stackability	4 pieces	4 pieces	4 pieces	4 pieces	4 pieces	4 pieces	4 pieces	4 pieces

OPTIONS | LINKING AND STACKING TABLES SERIES

- Chrome-plated frame
- Glued
- Felt floor protectors
- Teflon floor protectors
- 2 castors on the long side
- ASSODUR® edge
- Chair suspension
- Guide rails with Tidy Box
- Bag hook



CIRCULAR SEGMENT TABLES:

Easily stackable without dismantling to save space: Simply lift a few centimetres and slide it over the lower table; the welded frame makes them particularly stable.



9999.501 Circular segment table



9999.501 Circular segment table optionally with 2 fixed castors lengthwise



9999.501 Circular segment table stackable up to 4 tables

9999 | CIRCULAR SEGMENT TABLE



- welded, absolutely robust metal frame, scratch-resistant powder-coated
- side parts made of round tube (40 x 2 mm), frames made of square tube (40 x 20 x 2 mm)
- plastic floor protectors with level compensation
- 25 mm thick finish board in a particularly scratch-resistant and shock-proof design, rounded corners R 4 cm
- as standard we deliver the table with a 3 mm plastic edge in the colour of the top, for finish selection see A2S material overview
- alternative compact tabletop, robust, highly compressed and black coloured wood fibre board with melamine coating, 12 mm thick, edges softly rounded, corners R 4 cm, for finish selection see A2S material overview



9999.501 Circular segment table
Table combination for meetings with up to 12 people

TABLE COMBINATIONS WITH CIRCULAR SEGMENT TABLE

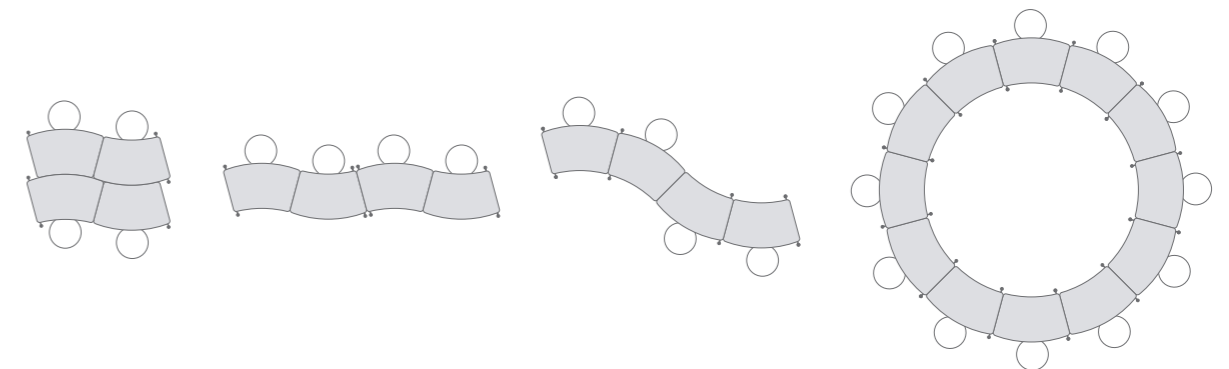

Group work
Lesson
Meeting

4 4 4 12

9999 SERIES | CIRCULAR SEGMENT TABLE **PROTRUDING LEGS ON TRANSVERSE SIDE**



MODEL	9999.501
Dimensions W x D in cm	96.7 x 61.4 cm
Weight · Size 6	15.2 kg
Stackability	4 pieces

OPTIONS

Chrome-plated frame	■
Glued	■
Felt floor protectors	■
Teflon floor protectors	■
2 castors on the long side	■
ASSODUR® edge	■
Chair suspension	■





1007.001 Penta table, stackable



1007.001 Penta table, stackable optionally with 2 fixed castors lengthwise



1007.001 Penta table stackable up to 5 tables

1007 | PENTA TABLE, STACKABLE



- welded, absolutely robust metal frame, scratch-resistant powder-coated
- side parts made of round tube (40 x 2 mm), frames made of square tube (40 x 20 x 2 mm)
- plastic floor protectors with level compensation
- 25 mm thick finish board in a particularly scratch-resistant and shock-proof design
- as standard we deliver the table with a 3 mm plastic edge in the colour of the top, for finish selection see A2S material overview



The penta tables are versatile for use in administration and classrooms. Castors facilitate the flexible combination of the tables for meetings, group work and classic frontal teaching.

TABLE COMBINATIONS WITH PENTA TABLE

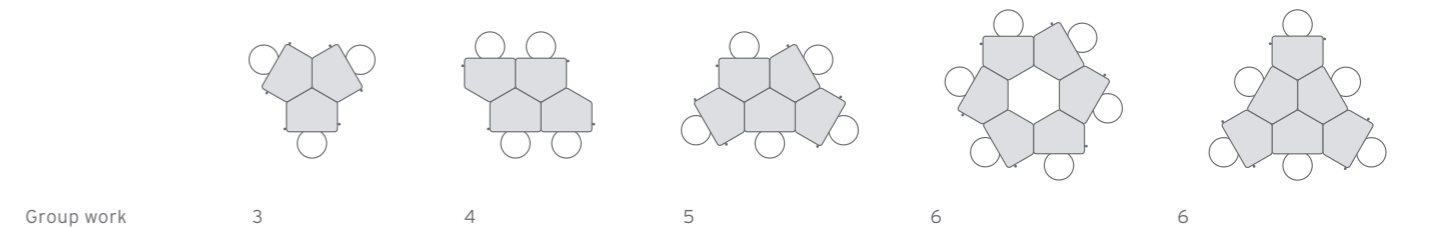

Group work 3 4 5 6 6

1007 | PENTA TABLE, STACKABLE

PROTRUDING LEGS ON LONGITUDINAL SIDE



MODEL	1007.001
Dimensions W x D in cm	70 x 60
Weight · Size 6	15 kg
Stackability	5 pieces

OPTIONS

Felt floor protectors	■
Teflon floor protectors	■
2 castors on the long side	■
ASSODUR® edge	■
Chair suspension	■
Guide rails with Tidy Box	■
Book storage basket zinc-plated	■



Solid beech wood table frame, with wooden frame on all sides



5822 4-legged rectangular table with wooden frame, Frame of wooden studs half round beech lacquered

WOODEN TABLES

- solid beech wooden table frame from sustainable forestry, environmentally friendly lacquered with water-based lacquer
- 25 mm thick working surface with additional melamine resin coating, thus scratch-resistant, shock-proof and glare-free
- as standard we deliver the table with a 3 mm plastic edge in the colour of the top, for finish selection see A2S material overview
- many different table top sizes and shapes
- optional edge beech concealed edge band crowned natural lacquered
- tables available in heights 72 or 75 cm



5822 Table with wooden frame
7414 WAVE cantilever chair with seat and back upholstery

WOODEN TABLES	70 CM					80 CM				
MODEL	5820	5821	5822	5823	5824	5800	5801	5802	5803	5804
Dimensions W x D in cm	70 x 70	120 x 70	140 x 70	160 x 70	190 x 70	80 x 80	120 x 80	140 x 80	160 x 80	190 x 80
Weight H 72/75 cm	16.5/17 kg	24.5/25 kg	26.5/27 kg	31.5/32 kg	35.5/36 kg	19.5/20 kg	27.5/28 kg	30.5/31 kg	34.5/35 kg	39.5/40 kg

WOODEN TABLES	TRAPEZOIDAL		SEMICIRCLE	
MODEL	5817	5807	5818	5808
Dimensions W x D in cm	140 x 70 x 70	160 x 80 x 80	140 x 70	160 x 80
Weight H 72/75 cm	26.5/27 kg	32.5/33 kg	26,5/27 kg	32,5/33 kg

OPTIONS	RECTANGLE	TRAPEZOIDAL	SEMICIRCLE
Stained frame	■	■	■
Glued	■	■	■
Concealed edge band crowned	■	■	■
Round cable outlet	■		
Grille cable channel	■		
Felt floor protectors	■	■	■
Table height optional 72 or 75 cm	■	■	■

TABLE ATTACHMENTS, FRONT AND SIDE PANELS FOR METAL TABLE SYSTEM

- cover board as well as sides and front with melamine coated finishboard in particularly scratch-resistant and shock-proof design, 60 Series in corpus construction or 20 Series with holder made of round tube 40 x 2 mm powder-coated, see A2S material overview
- 3 mm and 1 mm plastic edge in board colour, for finish selection see A2S material overview
- 20 Series available with one-sided or double-sided linking
- fixing of front and side panels with steel panel holder, powder-coated, see A2S material overview



20 Series elegant appearance: continuous table leg and with matching front and side panels



20 Series high and deep enough for standard folders

TABLE TOPS | HEIGHT 36 CM FOR RECTANGULAR TABLES



MODEL	2053.080	2053.090	2053.100	2053.120	2053.140	2053.160	2053.180	2053.200
Freestanding								
Linking one-sided left/right	2053.081	2053.091	2053.101	2053.121	2053.141	2053.161	2053.181	2053.201
Linking double-sided	2053.082	2053.092	2053.102	2053.122	2053.142	2053.162	2053.182	2053.202
Dimensions W x D	80 x 36 cm	90 x 36 cm	100 x 36 cm	120 x 36 cm	140 x 36 cm	160 x 36 cm	180 x 36 cm	200 x 36 cm

TABLE ATTACHMENTS | HEIGHT 36 CM FOR PENTAGONAL TABLES FOR HEXAGONAL TABLES



MODEL	2055.070	2054.070	2054.080
Freestanding			
Linking one-sided left/right	2055.071	2054.071	2054.081
Linking double-sided	2055.072	2054.072	2054.083
Dimensions W x D	120 x 120 cm	120 x 120/70 cm	137 x 137/80 cm

OPTIONS | TABLE ATTACHMENTS

Chrome-plated frame (20 Series only)
Glued
Table top with corner radius 40 mm (only table attachments for rectangular tables)

TABLE ATTACHMENTS | DEPTH 26 CM FOR RECTANGULAR TABLES | 22.5 OR 32 CM HEIGHT FOR CORNER SOLUTIONS | 36 CM HEIGHT



MODEL	6010	6011	6012	6013	6014	6015	6016	6020	6021	6022	6023	6024
Table width in cm	80	90	120	140	160	180	190	80 x 80	110 x 110	80 x 80	80 x 80	80 x 80
For corner board								90°	90°	30°	45°	60°
No. of compartments	2	2	3	4	4	5	5	1	2	1	1	1

FRONT AND SIDE PANELS | HEIGHT 33 CM



MODEL	2050.060	2050.070	2050.080	2050.090	2050.100	2050.120	2050.140	2050.150	2050.160	2050.180	2050.200
Front and side panel											
Linking one-sided left/right	2050.061	2050.071	2050.081	2050.091	2050.101	2050.121	2050.141	2050.151	2050.161	2050.181	2050.201
Linking double-sided	2050.062	2050.072	2050.082	2050.092	2050.102	2050.122	2050.142	2050.152	2050.162	2050.182	2050.202
For table depth	60 cm	70 cm	80 cm	90 cm	100 cm	120 cm	140 cm	150 cm	160 cm	180 cm	200 cm
Dimensions B	46.8 cm	56.8 cm	66.8 cm	76.8 cm	86.8 cm	106.8 cm	126.8 cm	136.8 cm	146.8 cm	166.8 cm	186.8 cm
	50.8 cm	60.8 cm	70.8 cm	80.8 cm	90.8 cm	110.8 cm	130.8 cm	140.8 cm	150.8 cm	170.8 cm	190.8 cm
	54.8 cm	64.8 cm	74.8 cm	84.8 cm	94.8 cm	114.8 cm	134.8 cm	144.8 cm	155.8 cm	174.8 cm	194.8 cm

ACCESSORIES FOR TABLE SYSTEMS



Individually extendable and linkable

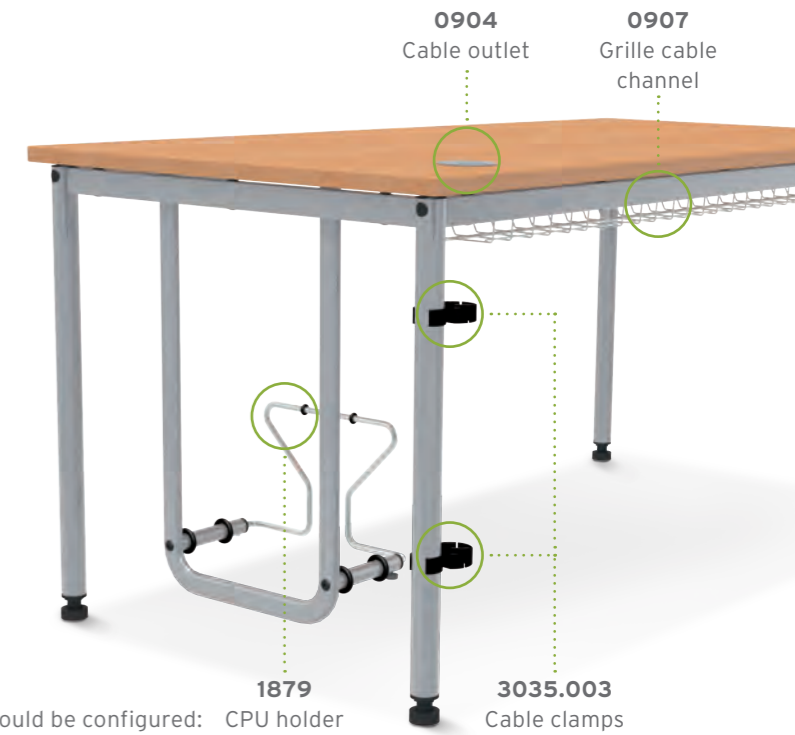

EXAMPLE

This is how your table could be configured: CPU holder Cable clamps

CONNECTOR KEYBOARD DRAWER SCHUKO SOCKET FIXED CASTOR



MODEL	0224	0227	0909	0185	0179
Description	Connection clamp for beech table system oval wood, galvanised steel	Universal connector for 1000 and 2000 table system, galvanized steel	Keyboard drawer 53 x 5,5 x 21 cm	6-way Schuko socket black-grey, with 3 m supply cable	for retrofitting on transverse or longitudinal sides of the tables

WIRE GRILLE CABLE CHANNEL

CABLE HOLDER



MODEL	0908	0906	0907	0163
Description	450 mm length	880 mm Length	1280 mm length	1250 mm length, vertical, silver, can be shortened if required for office, meeting and writing tables

CABLE OUTLET

CABLE CLAMP

CPU HOLDER

INLAY SHEET



MODEL	0904	3035.002	3035.003	1879	520835
Description	Plastic, matt chrome-plated Ø 80 mm	Die-cast zinc matt nickel-plated Ø 90 mm	Plastic, Ø 38-40 mm	incl. additional fixing under the table top, not for sliding top tables, adjustable from 160-255 mm, max. height of CPU: 500 mm, oval and square tube powder-coated	Inlay sheet in CPU holder for retrofitting Mini PC/Tower



Table partition with fabric cover:
Pinboard, privacy and glare protection in one

FLEXIBLE TABLE PARTITION SYSTEM

- 46 cm high partition wall, quickly mountable to the tabletop using allen key and easily retrofitted
- table partition wall system in 2 different versions:
3-layer finish board, 25 mm (E1) with 3 mm plastic edge in board colour or robust softwood sandwich board as pinboard with fabric cover according to A2S colour chart, sound-absorbing
- fastening to round steel tube, Ø 40 x 2 mm, powder-coated or chrome-plated
- suitable for 1000 and 2000 table systems from 60 to 200 cm width
- corner solutions possible
- you will find our selection of fabrics, finishes and steel colours in the A2S material overview

OPTIONS

Chrome-plated frame

Material groups 1-3

Magnetic

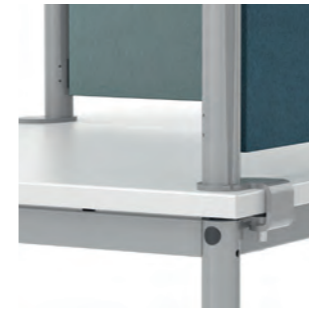

Mounting by means of Allen screw on the table top; installation of the partition walls is also possible on triangular and semicircular tables. You will find the A2S table systems from p. 84.



Coherent colour concept: The finish and fabric colours of the partition wall system match the table tops and table panels as well as the chairs' upholstery colours.



Connection of
T-shaped partition walls



The 46 cm high partition walls allow more concentrated work due to less distraction, also available with tables with one-sided or double-sided linking.

TABLE PARTITION SYSTEM | HEIGHT 46 CM



for single tables	1099.060	1099.070	1099.080	1099.090	1099.100	1099.120	1099.140	1099.150	1099.160	1099.180	1099.200
Partition wall width in cm	46.8	56.8	66.8	76.8	86.8	106.8	126.8	136.8	146.8	166.8	186.8
for side partition*	1098.060	1098.070	1098.080	1098.090	1098.100						
Partition wall width in cm	46.8	56.8	66.8	76.8	86.8						
for one-sided linking	1099.061	1099.071	1099.081	1099.091	1099.101	1099.121	1099.141	1099.151	1099.161	1099.181	1099.201
Partition wall width in cm	50.8	60.8	70.8	80.8	90.8	110.8	130.8	140.8	150.8	170.8	190.8
for double-sided linking	1099.062	1099.072	1099.082	1099.092	1099.102	1099.122	1099.142	1099.152	1099.162	1099.182	1099.202
partition wall width in cm	54.8	64.8	74.8	84.8	94.8	114.8	134.8	144.8	154.8	174.8	194.8
for table width, depth in cm	60	70	80	90	100	120	140	150	160	180	200

*optional with metal clamp for T-shaped connection without support column



9232.800 Rolling container handleless with central lock on robust castors with stable cover board
1 utensil drawer, 1 drawer 2 HU, 2 drawers of 3 HU

CONTAINERS/ROLLING CONTAINERS AND BASE UNITS



- containers in 2 different versions:
height 56 cm with sturdy castors for stowing under the table
height 49 cm as a permanently mounted base unit
- low-emission finishboard (19 mm) with 2 mm plastic edge in board colour, for finish selection see A2S material overview
- robust fittings and drawers
- including central lock
- accessories for interior separation
- handleless rolling containers with integrated damping function
- handles in different shapes selectable - contact your A2S area manager
- info: the height of the drawers is indicated in "HU"; 1 HU = 5.3 cm



9109.601 1 utensil drawer, 1 drawer 2 HU, 2 drawers of 3 HU



9109.603 1 utensil drawer, 2 drawers of 2 HU each, 1 drawer 4 HU



9109.604 1 utensil drawer, 1 drawer 2 HU, 1 drawer 6 HU
incl. suspension file insert DIN A4

9109 SERIES | ROLLING CONTAINER | W 44 X H 57 CM (FOR STOWING UNDER THE TABLE)

MODEL 60 CM DEEP	9109.601	9109.603	9109.604*	9109.605
MODEL 80 CM DEEP	9109.801	9109.803	9109.804*	9109.805
Equipment	Utensil drawer 1 HU 1 drawer 2 HU 2 drawers à 3 HU	Utensil drawer 1 HU 2 drawers à 2 HU 1 drawer 4 HU	Utensil drawer 1 HU 1 drawer 2 HU 1 drawer 6 HU*	lockable door right/left selectable incl. 1 shelf

9231/9232 SERIES | ROLLING CONTAINER HANDLELESS | W 44 X H 57 CM (FOR STOWING UNDER THE TABLE)

MODEL 60 CM DEEP	9231.600	9232.600
MODEL 80 CM DEEP	9231.800	9232.800
Equipment	Utensil drawer 1 HU 1 Drawer 2 HU 1 drawer 6 HU	Utensil drawer 1 HU 1 Drawer 2 HU 2 drawers 3 HU

9119 SERIES | BASE UNITS | W 43 X H 50 CM

MODEL 65 CM DEEP	9119.701	9119.703	9119.704*	9119.705	9115.701
MODEL 75 CM DEEP	9119.801	9119.803	9119.804*	9119.805	
Equipment	Utensil drawer 1 HU 1 drawer 2 HU 2 drawers à 3 HU	Utensil drawer 1 HU 2 drawers à 2 HU 1 drawer 4 HU	Utensil drawer 1 HU 1 drawer 2 HU 1 drawer 6 HU*	lockable door right/left selectable incl. 1 shelf	2 drawers each 12,4 cm

*incl. Suspension file insert DIN A4

ACCESSORIES FOR ROLLING CONTAINERS AND BASE UNITS

ADJUSTMENT BOARD	STAMP HOLDER	PARTITION WALLS	HANDLES
0933 for subdivision	0931 Stamp holder strip	0934 DIN A4	0935 DIN A5
			contact your A2S area manager

POLSTER COVER FOR ROLLING CONTAINER

D 59 cm - 9100.600
D 79 cm - 9100.800
Cover fabrics price group 1-4

POLSTER COVER FOR ROLLING CONTAINER HANDLELESS

D 59 cm - 9200.600
D 79 cm - 9200.800
Cover fabrics price group 1-4





Multifunctional benefit with back wall in magnetic design



9131.080 Pull-out pantry body pure white U400, front maple D033



9131.080 Pull-out pantry with 2 shelves and 4 Tidy Boxes



Large handle for comfortable opening



9135.080 Pull-out pantry with suspension file

CONTAINERS/ PULL-OUT PANTRIES



- low-emission finish board (19 mm) with gapless plastic edge in board colour, for finish selection see A2S material overview
- front colour freely selectable
- back wall optional white magnetic or as pin board with cork coating
- complete opening by full extension
- lockable
- 3 different equipment variants: Storage compartments with suspension file or Tidy Boxes and bag compartment
- Tidy Boxes in 2 different sizes selectable: 4 x small or 2 x large or 2 x small and 1 x large



Lots of storage space directly at the workplace
9133.080 Pull-out pantry with 3 shelves, lockable
5580.149 OFFICE desk motorised height adjustable
9335 WAVE gas-lift swivel chair with seat and back upholstered with wave padding



Combination of privacy screen and storage space. The height is chosen exactly so that the shelf can be used as a counter for small meetings.

913ER SERIES | PULL-OUT PANTRIES



MODEL	9131.080	9132.080	9133.080	9134.080	9135.080	9136.080
Equipment	2 storage compartments 1 bag compartment 4 Tidy Boxes	2 storage compartments 1 bag compartment 4 Tidy Boxes	3 storage compartments	3 storage compartments	2 storage compartments 1 pocket compartment hanging file	2 storage compartments 1 pocket compartment hanging file
Dimensions W/H/D	45 x 109 x 82 cm	45 x 109 x 82 cm	45 x 109 x 82 cm	45 x 109 x 82 cm	45 x 109 x 82 cm	45 x 109 x 82 cm
Table on the side of the table	left	right	left	right	left	right
Suitable table depth	80 cm	80 cm	80 cm	80 cm	80 cm	80 cm
Lockable	■	■	■	■	■	■

OPTIONS

Magnetic backplane	■	■	■	■	■	■
Back wall covered with cork	■	■	■	■	■	■



A2S CORPUS FURNITURE

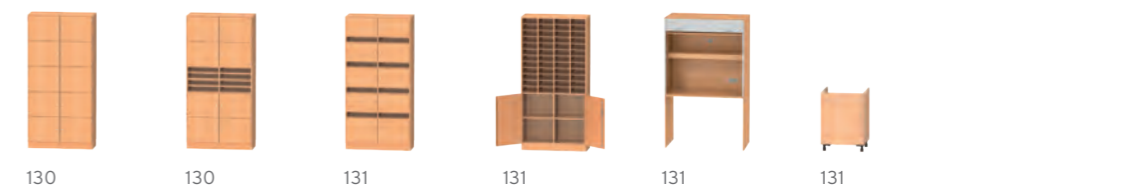
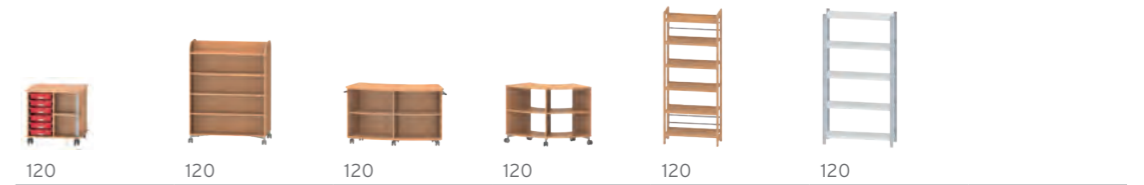

CUSTOM-MADE CABINETS

Things always have to be stored well and safely in educational institutions. Ideally, our A2S cabinet system in the EURO grid DIN 18000 can be adapted to any situation, from a single item to a wall unit to a built-in cabinet. This means that a solution can always be found for the most diverse rooms. And you can be sure that you purchase A2S quality from Germany, persistent and resilient.

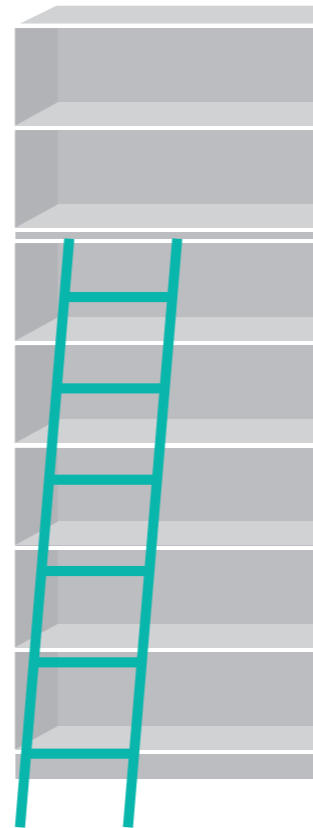

BASIC CONSTRUCTION

- low-emission, 19 mm thick 3-layer fish board according to DIN EN 14 322 (E1), shock-proof, scratch- and abrasion resistant
- the plastic edges in board colour are 1-2 mm thick (info p. 170)
- all cabinets are firmly doweled and glued ex works; it guarantees high stability and smooth, quick assembly
- all back walls made of 8 mm thick, low-emission 3-layer finish board are grooved and glued all around
- shelves on metal shelf supports with pull-out protection are adjustable by means of row hole drilling
- the opening hinged doors can be opened by the stable, visible all-metal bands up to 240 degrees
- locks with exchangeable cylinder core are optionally available with plate or pin cylinder available
- different base variants enable an optimal adaptation to the room and use. Standard bases are available with independently selectable finish and also up to 3 FH, also roller frames with rubberised castors are possible - thus makes them mobile cabinets

A2S CABINET SYSTEM STANDARD DIMENSIONS

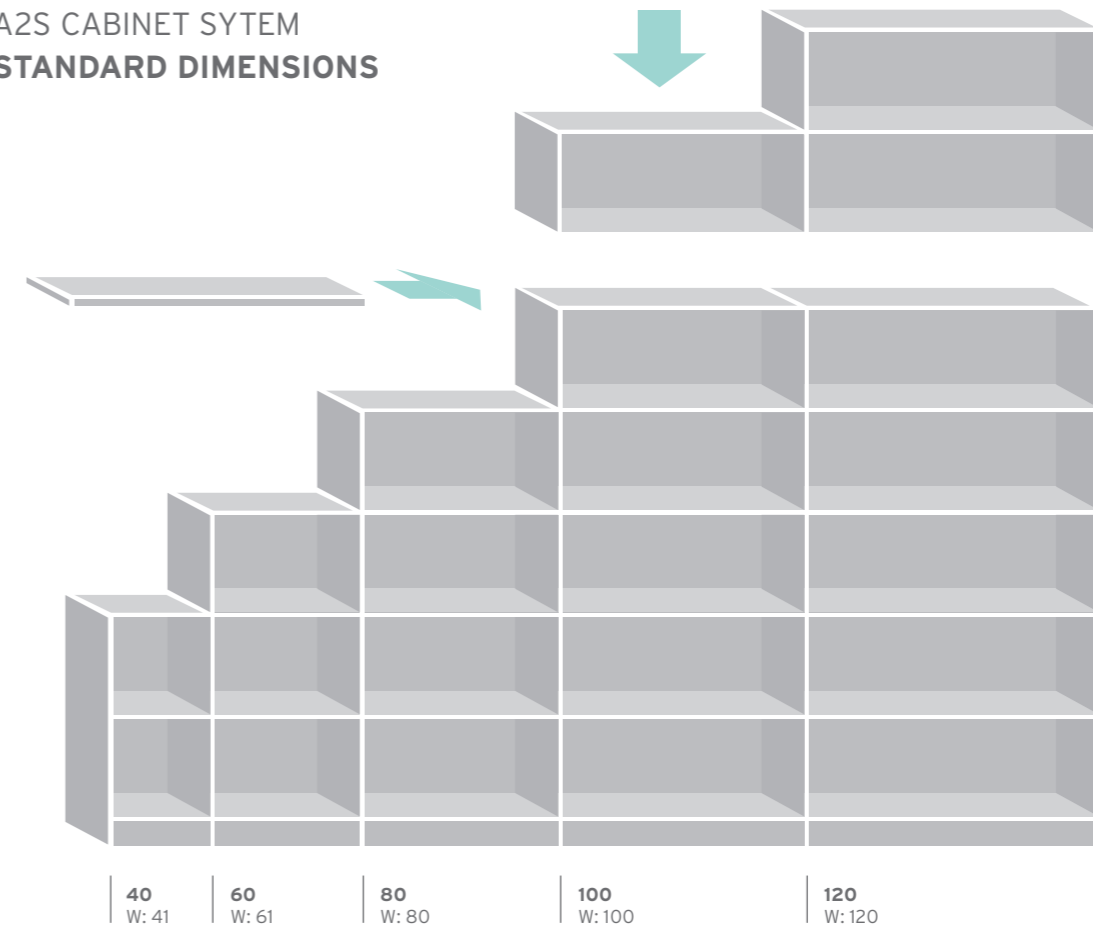

POSSIBILITIES FOR INDIVIDUAL ADAPTATION

- heights and depths of the cabinets can be modified in a grid of 32
- widths can be freely selected individually to make the most of the room
- maximum corpus dimensions of 125 x 250 x 70 cm are possible
- possible base heights for wooden base: 60, 100, 150 cm
- 1-part and 2-part combination cabinets, see pages 106/107

CH = Cabinet height
CorH = Corpus height
CAH = Corpus attachment height
FH = Folder height
1 FH = 38.4 cm









Cabinet depths:
42 cm or 58 cm,
plus front thickness
of 2 cm
e.g. for hinged doors

Cabinet heights: refer
to a 10 cm high base

COMBINATION CABINETS 1-PART



■ 1-part combination cabinets have fixed combinations in 5 FH

COMBINATION CABINETS 1-DOOR	LOCKABLE		COMBINATION CABINETS 2-DOOR SPLIT DOORS	LOCKABLE ON ONE SIDE		LOCKABLE ON BOTH SIDES	
							
FH	5	5	FH	5	5	5	5
Height	204 cm	204 cm	Height with base	204 cm	204 cm	204 cm	204 cm
Number of shelves	2+1	2+1	Number of shelves	6	6	6	6
Center panel			Center panel	■	■	■	■
DEPTH	44 CM	60 CM	DEPTH	44 CM	60 CM	44 CM	60 CM
Width 41 cm	4235.250	4236.250	Width 80 cm	4377.650	4378.650	4353.650	4354.650
Width 61 cm	4235.450	4236.450	Width 100 cm	4377.950	4378.950	4353.950	4354.950
			Width 120 cm	4377.850	4378.850	4353.850	4354.850

COMBINATION CABINETS 2-PART

- combinable from two freely selectable cabinet types
- the combination top cabinet (2 FH/3 FH) and top cabinet (2 FH) configure from basic cabinet 2 FH and 3 FH
- the combination top cabinet must have the same width as the base cabinet, two narrow base cabinets and one wide combination top cabinet are not possible



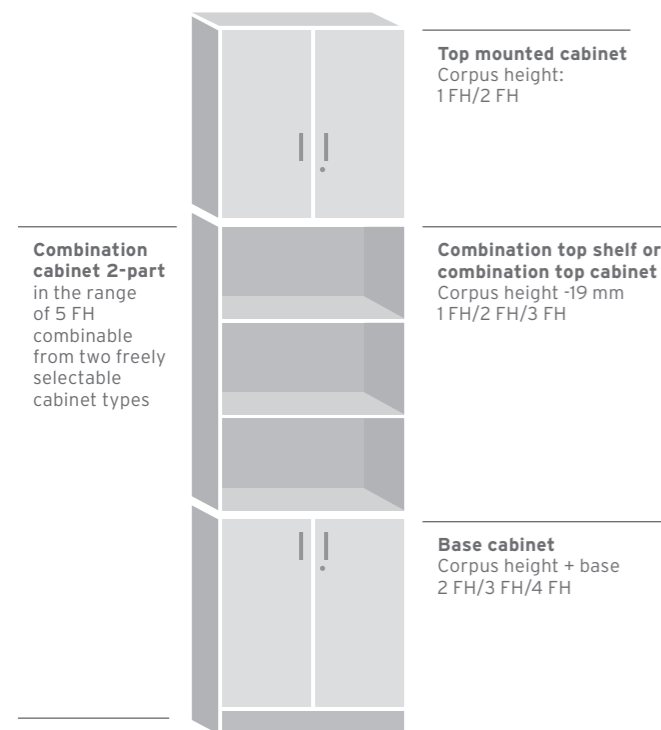



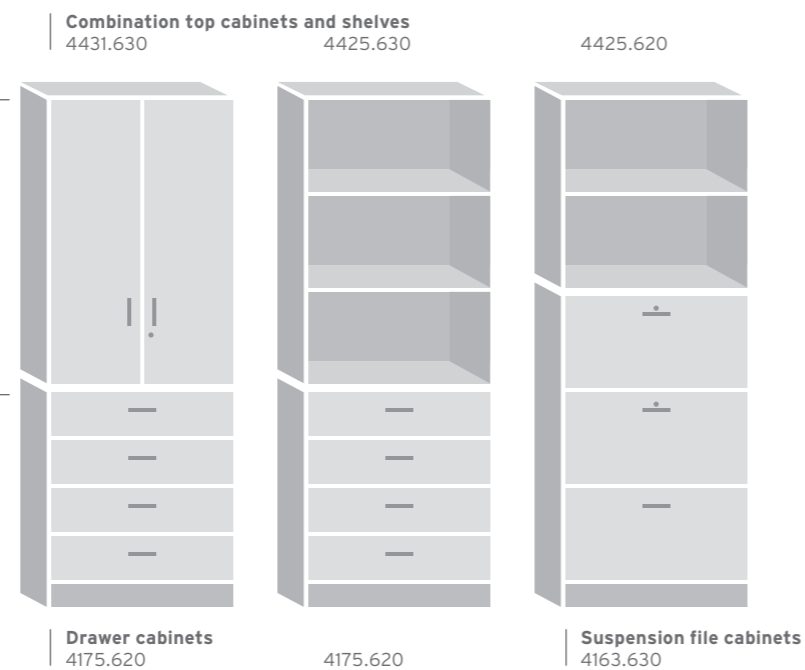

STRUCTURE OF CABINET COMBINATIONS



EXAMPLES COMBINATION CABINETS 2-PART

consisting of base cabinet + combination top cabinet or shelf



COMBINATION CABINETS 2-DOOR	LOCKABLE ON ONE SIDE		LOCKABLE ON BOTH SIDES		WITH SUSPENSION FILE CABINET		
							
FH	5	5	5	5	5	5	5
Height	204 cm	204 cm	204 cm	204 cm	204 cm	204 cm	204 cm
Number of shelves	2+2	2+2	4+2	4+2	2	1	1
Number of extracts					2	3	3
Center panel	lower 2 FH	lower 2 FH	continuously	continuously			
DEPTH	44 CM	60 CM	44 CM	60 CM	44 CM	44 CM	60 CM
Width 80 cm	4215.650	4216.650	4485.650	4486.650	4153.650	4155.650	4156.650
Width 100 cm	4215.950	4216.950	4485.950	4486.950			
Width 120 cm	4215.850	4216.850	4485.850	4486.850			

Due to the additional shelf, the combination top cabinet is always 19 mm lower in order to be able to keep to the folder heights and to avoid height offset in cabinet walls.

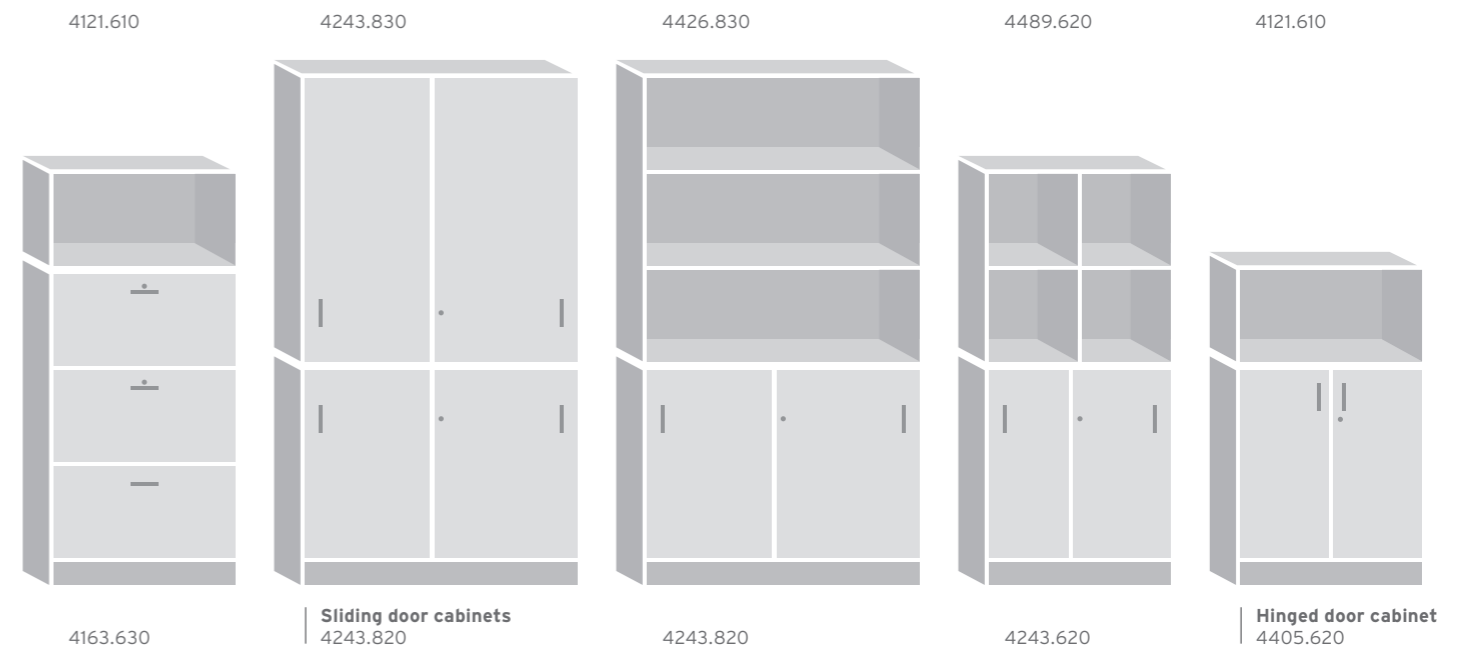

SHELVES



SHELVING UNITS WITHOUT CENTER PANEL										TOP MOUNTED SHELVES*		
FH	5	5	4	4	3	3	2	2	1	1		
Height with base	204 cm	204 cm	165 cm	165 cm	127 cm	127 cm	89 cm	89 cm				
Height top cabinet							79 cm	79 cm	40 cm	40 cm		
Height combi top cabinet					115 cm	115 cm	77 cm	77 cm	38 cm	38 cm		
Number of shelves	4	4	3	3	2	2	1	1				
DEPTH	42 CM	58 CM	42 CM	58 CM	42 CM	58 CM	42 CM	58 CM	42 CM	58 CM		
Width 41 cm	4425.250	4426.250	4425.240	4426.240	4425.230	4426.230	4425.220	4426.220	4121.210	4122.210		
Width 61 cm	4425.450	4426.450	4425.440	4426.440	4425.430	4426.430	4425.420	4426.420	4121.410	4122.410		
Width 80 cm	4425.650	4426.650	4425.640	4426.640	4425.630	4426.630	4425.620	4426.620	4121.610	4122.610		
Width 100 cm	4425.951	4426.951	4425.941	4426.941	4425.931	4426.931	4425.921	4426.921	4121.911	4122.911		
Width 120 cm	4425.850	4426.850	4425.840	4426.840	4425.830	4426.830	4425.820	4426.820	4121.810	4122.810		

*Add-on shelves in 2 FH result from the 2 FH shelf, configured without base.

SHELVING UNITS WITH CENTER PANEL										TOP MOUNTED SHELVES*		
FH	5	5	4	4	3	3	2	2	1	1		
Height with base	204 cm	204 cm	165 cm	165 cm	127 cm	127 cm	89 cm	89 cm				
Height top cabinet							79 cm	79 cm	40 cm	40 cm		
Height combi top cabinet					115 cm	115 cm	77 cm	77 cm	38 cm	38 cm		
Number of shelves	8	8	6	6	4	4	2	2				
DEPTH	42 CM	58 CM	42 CM	58 CM	42 CM	58 CM	42 CM	58 CM	42 CM	58 CM		
Width 80 cm	4489.650	4490.650	4489.640	4490.640	4489.630	4490.630	4489.620	4490.620	4123.610	4124.610		
Width 100 cm	4489.950	4490.950	4489.940	4490.940	4489.930	4490.930	4489.920	4490.920	4123.910	4124.910		
Width 120 cm	4489.850	4490.850	4489.840	4490.840	4489.830	4490.830	4489.820	4490.820	4123.810	4124.810		

*Add-on shelves in 2 FH result from the 2 FH shelf, configured without base.

SUSPENDED SHELVES WITHOUT CENTER PANEL				WITH CENTER PANEL		
FH	2	1	2	1		
Height	79 cm	40 cm	79 cm	40 cm		
Number of shelves	1		2			
Center panel			■	■		
DEPTH	42 CM	42 CM	42 CM	42 CM		
Width 41 cm	4939.220	4939.210				
Width 61 cm	4939.420	4939.410				
Width 80 cm	4939.620	4939.610	4941.620	4941.610		
Width 100 cm	4939.921	4939.911	4941.920	4941.910		
Width 120 cm	4939.820	4939.810	4941.820	4941.810		

CORNER SHELVES					TOP MOUNTED SHELVES*	
OH	5	4*	3*	2*	2	1
Height	204 cm	165 cm	127 cm	89 cm	79 cm	40 cm
Number of shelves	4	3	2	1	1	
DEPTH	70 CM	70 CM	70 CM	70 CM	70 CM	70 CM
Width 70 cm	4062.050	4062.040	4062.030	4062.020	4063.020	4063.010

The bases of corner shelves must always be covered.
*For heights 2-4 FH, additional cover boards must be assembled.



FH = folder height
Height specifications refer to a 10 cm high base.

HINGED DOOR CABINETS



1-DOOR | LOCKABLE TOP MOUNTED CABINETS*



FH	5	5	4	4	3	3	2	2	1	1
Height with base	204 cm	204 cm	165 cm	165 cm	127 cm	127 cm	89 cm	89 cm		
Height top cabinet							79 cm	79 cm	40 cm	40 cm
Height combi top cabinet					115 cm	115 cm	77 cm	77 cm	38 cm	38 cm
Number of shelves	4	4	3	3	2	2	1	1	0	0
DEPTH	44 CM	60 CM	44 CM	60 CM	44 CM	60 CM	44 CM	60 CM	44 CM	60 CM
Width 41 cm	4401.250	4402.250	4401.240	4402.240	4401.230	4402.230	4401.220	4402.220	4203.210	4204.210
Width 61 cm	4401.450	4402.450	4401.440	4402.440	4401.430	4402.430	4401.420	4402.420	4203.410	4204.410

*Top-mounted cabinets in 2 FH result from the 2 FH cabinet, configured without base.

2-DOOR | LOCKABLE ON ONE SIDE WITHOUT CENTER PANEL TOP MOUNTED CABINETS*



FH	5	5	4	4	3	3	2	2	1	1
Height with base	204 cm	204 cm	165 cm	165 cm	127 cm	127 cm	89 cm	89 cm		
Height top cabinet							79 cm	79 cm	40 cm	40 cm
Height combi top cabinet					115 cm	115 cm	77 cm	77 cm	38 cm	38 cm
Number of shelves	4	4	3	3	2	2	1	1	0	0
DEPTH	44 CM	60 CM	44 CM	60 CM	44 CM	60 CM	44 CM	60 CM	44 CM	60 CM
Width 80 cm	4431.650	4432.650	4431.640	4432.640	4431.630	4432.630	4431.620	4432.620	4213.610	4214.610
Width 100 cm	4431.950	4432.950	4431.940	4432.940	4431.930	4432.930	4431.920	4432.920	4213.910	4214.910
Width 120 cm	4431.850	4432.850	4431.840	4432.840	4431.830	4432.830	4431.820	4432.820	4213.810	4214.810

*Top-mounted cabinets in 2 FH result from the 2 FH cabinet, configured without base.

2-DOOR | LOCKABLE ON ONE SIDE WITH CENTER PANEL TOP MOUNTED CABINETS*



FH	5	5	4	4	3	3	2	2	1	1
Height with base	204 cm	204 cm	165 cm	165 cm	127 cm	127 cm	89 cm	89 cm		
Height top cabinet							79 cm	79 cm	40 cm	40 cm
Height combi top cabinet					115 cm	115 cm	77 cm	77 cm	38 cm	38 cm
Number of shelves	8	8	6	6	4	4	2	2	0	0
Center panel	■	■	■	■	■	■	■	■	■	■
DEPTH	44 CM	60 CM	44 CM	60 CM	44 CM	60 CM	44 CM	60 CM	44 CM	60 CM
Width 80 cm	4405.650	4406.650	4405.640	4406.640	4405.630	4406.630	4405.620	4406.620	4223.610	4224.610
Width 100 cm	4405.950	4406.950	4405.940	4406.940	4405.930	4406.930	4405.920	4406.920	4223.910	4224.910
Width 120 cm	4405.850	4406.850	4405.840	4406.840	4405.830	4406.830	4405.820	4406.820	4223.810	4224.810

*Top-mounted cabinets in 2 FH result from the 2 FH cabinet, configured without base.

2-DOOR | LOCKABLE ON BOTH SIDES WITH CENTER PANEL TOP MOUNTED CABINETS*



FH	5	5	4	4	3	3	2	2	1	1
Height with base	204 cm	204 cm	165 cm	165 cm	127 cm	127 cm	89 cm	89 cm		
Height top cabinet							79 cm	79 cm	40 cm	40 cm
Height combi top cabinet					115 cm	115 cm	77 cm	77 cm	38 cm	38 cm
Number of shelves	8	8	6	6	4	4	2	2	0	0
Center panel	■	■	■	■	■	■	■	■	■	■
DEPTH	44 CM	60 CM	44 CM	60 CM	44 CM	60 CM	44 CM	60 CM	44 CM	60 CM
Width 80 cm	4441.650	4446.650	4441.640	4446.640	4441.630	4446.630	4441.620	4446.620	4225.610	4226.610
Width 100 cm	4441.950	4446.950	4441.940	4446.940	4441.930	4446.930	4441.920	4446.920	4225.910	4226.910
Width 120 cm	4441.850	4446.850	4441.840	4446.840	4441.830	4446.830	4441.820	4446.820	4225.810	4226.810

*Top-mounted cabinets in 2 FH result from the 2 FH cabinet, configured without base.

WALL UNITS



WALL UNITS	1-DOOR ONE-SIDED LOCKABLE	2-DOOR ONE-SIDED LOCKABLE	2-DOOR ONE-SIDED LOCKABLE WITH CENTER PANEL	2-DOOR LOCKABLE ON BOTH SIDES WITH CENTER PANEL
FH	2	2	1	2
Height	79 cm	79 cm	40 cm	79 cm
Number of shelves	1	1	0	2
DEPTH	44 CM	44 CM	44 CM	44 CM
Width 41 cm	4931.220			
Width 61 cm	4931.420			
Width 80 cm		4933.620	4933.610	4935.620
Width 100 cm		4933.920	4933.910	4935.920
Width 120 cm		4933.820	4933.810	4935.820

FH = folder height
Height specifications refer to a 10 cm high base.



SLIDING DOOR CABINETS



SLIDING DOOR CABINETS WITH CENTER PANEL				TOP MOUNTED CABINETS WITH CENTER PANEL			
FH	3	3	2	2	2	1	1
Height with base	127 cm	127 cm	89 cm	89 cm	89 cm		
Height top cabinet			79 cm	79 cm	79 cm	40 cm	40 cm
Height combi top cabinet	115 cm	115 cm	77 cm	77 cm	77 cm	38 cm	38 cm
Number of shelves	4	4	2	2	2	0	0
DEPTH	42 CM	58 CM	42 CM	58 CM	48 CM	42 CM	58 CM
Width 80 cm	4243.630	4244.630	4243.620	4244.620		4205.610	4206.610
Width 100 cm	4243.930	4244.930	4243.920	4244.920		4205.910	4206.910
Width 120 cm	4243.830	4244.830	4243.820	4244.820		4205.810	4206.810
Width 138 cm							4040.820

SLIDING DOOR CABINETS WITH CENTER PANEL, LOCKABLE



FH	5	5
Height	204 cm	204 cm
Number of shelves	8	8
Center panel	■	■
DEPTH	62 CM	62 CM
Width 240 cm	4708.850	4706.850

SUSPENSION FILE CABINETS



SUSPENSION FILE CABINETS*				COMBINATION CABINETS WITH TWO DOORS			DRAWER CABINETS
FH	3	3	2	2	5	5	5
Height	127 cm	127 cm	89 cm	89 cm	204 cm	204 cm	204 cm
Number of extracts	3	3	2	2	2	3	3
DEPTH	44 CM	60 CM	44 CM	60 CM	44 CM	44 CM	60 CM
Width 80 cm	4163.630	4164.630	4161.620	4162.620	4153.650	4155.650	4156.650

FH	2
Height	89 cm
Number of extracts	4
DEPTH	44 CM
Width 41 cm	4175.220
Width 61 cm	4175.420
Width 80 cm	4175.620

*can be combined with combination top cabinets

DRAWER CABINETS



ROLLER SHUTTER CABINETS



ROLLER SHUTTER CABINETS								
FH	5	5	4	4	3	3	2	2
Height with base	204 cm	204 cm	165 cm	165 cm	127 cm	127 cm	89 cm	89 cm
Number of shelves	4	4	3	3	2	2	1	1
DEPTH	42 CM	58 CM	42 CM	58 CM	42 CM	58 CM	42 CM	58 CM
Width 80 cm	4531.650	4532.650	4531.640	4532.640	4531.630	4532.630	4531.620	4532.620
Width 100 cm	4531.950	4532.950	4531.940	4532.940	4531.930	4532.930	4531.920	4532.920
Width 120 cm	4531.850	4532.850	4531.840	4532.840	4531.830	4532.830	4531.820	4532.820

ROLLER SHUTTER TOP CABINETS



FH	3	3	2	2	1	1
Height top cabinet	117 cm	117 cm	79 cm	79 cm	40 cm	40 cm
Height combi top cabinet	115 cm	115 cm	77 cm	77 cm	38 cm	38 cm
Number of shelves	2	2	1	1	0	0
DEPTH	42 CM	58 CM	42 CM	58 CM	42 CM	58 CM
Width 80 cm	4533.630	4534.630	4533.620	4534.620	4533.610	4534.610
Width 100 cm	4533.930	4534.930	4533.920	4534.920	4533.910	4534.910
Width 120 cm	4533.830	4534.830	4533.820	4534.820	4533.810	4534.810

SHUTTERS



White 9010 Aluminium look

MEDIA CADDY



MODEL	9126.001
Dimensions W/H/D in cm	70 x 94 x 70 cm
Number of shelves	1
Info	fully retractable, lockable roller shutter with 2 bow handles, incl. viewing rear panel, laptop shelf with full extension, ventilation grille, 6-way socket with 3 m cable, 4 castors, 2 of these lockable, cover plate with rounded corners (r=40 mm)



9126.001 Media Caddy

FH = folder height
Height specifications refer to a 10 cm high base.



MEDIA WORKSTATIONS



- space-saving integration of media workstations in one cabinet wall
- table top available in sizes ISO 4-7
- optionally with cable aperture or hinged built-in sockets
- back wall covered with fabric and useable as pin board, see A2S material overview
- revisable cover for simple, concealed cable routing between wall sockets and tabletop

MEDIA WORKSTATIONS



DEPTH	48/58 CM
Height	ISO size Table height 4-7
W 80 cm	4750.601
W 100 cm	4750.901
Number of shelves	1



CABINETS FOR SLIDING BOARDS



- ideally combined with the multifunctional board system 120 x 80 cm portrait or landscape format
- additional storage space behind the boards
- can be combined with hinged door and sliding door base units in special heights, for individual planning please contact your A2S area manager

SHELF EXTENSIONS	WITHOUT CENTER PANEL		WITH CENTER PANEL		SHELF EXTENSIONS WITH TIDY BOXES		BASE UNITS WITH TIDY BOXES	
	WITHOUT CENTER PANEL	WITH CENTER PANEL	SHELF EXTENSIONS WITH TIDY BOXES	WITH CENTER PANEL	BASE UNITS WITH TIDY BOXES	WITH CENTER PANEL	WITHOUT CENTER PANEL	
DEPTH	36/42/48/52/58 CM	36/42/48/52/58 CM	48/52 CM	48/52 CM	48 CM	48 CM	48 CM	48 CM
Height	87/128 cm	87/128 cm	87/128 cm	87/128 cm	76 cm	76 cm	76 cm	76 cm
W 70 cm	4730.600	4731.600	4740.070	4741.104	70 cm	105 cm	70 cm	105 cm
W 80 cm	4730.900	4731.900			Tidy Boxes small, number of Tidy Boxes	4128.421 12 pieces	4128.621 18 pieces	
W 100 cm	4730.800	4731.800			Tidy Boxes large, number of Tidy Boxes	4129.423 6 pieces	4129.623 9 pieces	
Number of shelves	2	4	2	3	Number of Tidy Boxes	8	12	



CHANGE
multifunctional cabinet with doors at the front and back:
storage, pinboard, whiteboard and room divider in one;
optionally as shelf cabinet or drawer cabinet with Tidy Boxes

CHANGE CABINET SERIES CABINETS AND SIDEBOARDS



- CHANGE cabinets made of low-emission 3-layer finish board (E1), scratch-resistant coating, for finish selection see A2S material overview
- with a particularly durable plastic edge even in humid climate
- modern rounded aluminium profile corners reduce the risk of injury and make the furniture more resistant
- doors lockable at front and back
- sturdy metal frame with 4 robust, rubberized plastic castors
- CHANGE sideboard without doors with lots of storage space, thanks to Tidy Boxes and large storage compartment



Rounded aluminium profiles

4130.502 CHANGE sideboard
offers space for 16 small or 8 large Tidy Boxes



CHANGE cabinet
with closed doors



4130.503 CHANGE drawer cabinet
with up to 12 small Tidy Boxes



4130.501 CHANGE Shelf cabinet
with 3 shelves

CHANGE	SHELF CABINET	DRAWER CABINET	SIDEBOARD	TIDY BOX SMALL	TIDY BOX LARGE
MODEL	4130.501 with 3 shelves	4130.503 with 2 shelves and 12 small Tidy Boxes	4130.502 without doors, 4 compartments horizontally and 4 compartments vertically	<input type="checkbox"/> 515267 <input type="checkbox"/> 515264 <input type="checkbox"/> 515266 <input type="checkbox"/> 515265 <input type="checkbox"/> 515263	<input type="checkbox"/> 515520 <input type="checkbox"/> 515517 <input type="checkbox"/> 515519 <input type="checkbox"/> 515518 <input type="checkbox"/> 515516
Dimensions W/H/D in cm	104 x 164 x 60	104 x 164 x 60	138 x 100 x 49	31 x 7,5 x 43	31 x 15 x 43

OPTIONS

Back panel cork linoleum ■ ■



4130.506 CHANGE Caddy with door, lockable



Rounded aluminium profiles

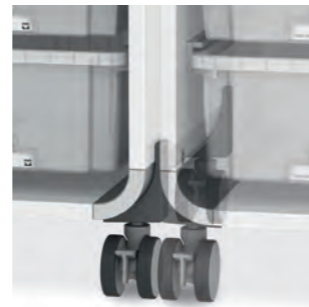

Magnetic linking system for connecting several caddies, e.g. to form a material cabinet



Optionally with magnetic sides

CHANGE CABINET SERIES CADDIES



- modern rounded aluminium profile corners reduce the risk of injury and make the furniture more resistant
- CHANGE Caddies made of low-emission 3-layer finish board (E1), for finish selection see A2S material overview
- sturdy metal frame with 4 robust, rubberized plastic castors
- multifunctional as storage space at the table, room divider or small counter



4130.505 CHANGE Caddy open on one side



4130.506 CHANGE Caddy with door



4130.507 CHANGE Caddy open on both sides



CHANGE CADDIES



MODEL	4130.505	4130.506	4130.507	9124
Design	Caddy open on one side	Caddy with door, lockable	Caddy open on both sides	Media Caddy with roller shutters and drawers
Dimensions W/H/D in cm	36 x 111 x 55	36 x 111 x 55	36 x 111 x 55	43 x 111 x 65
Weight	31 kg	36 kg	33 kg	56 kg
Number of compartments	2 x storage space 3 small Tidy Boxes or 1 small and 1 large Tidy Box	2 x storage space 3 small Tidy Boxes or 1 small and 1 large Tidy Box	1 x storage space 2 x 3 small Tidy Boxes or 2 x 1 small and 1 large Tidy Box	2 x drawers 1 x pull-out shelf 1 x storage compartment
Magnetic connector	■	■	■	■

OPTIONS

Magnetic side walls	■	■	■	■
---------------------	---	---	---	---

BOOKSHELVES AND ROOM DIVIDERS



	BOOK CUBE	BOOK TROLLEY			CIRCULAR SEGMENT SHELF	QUARTER CIRCLE SHELF
MODEL	4009.011	6432.001	6432.002	6432.003	4425.150	4801.921
Dimensions W/H/D	74 x 71 x 74 cm	90 x 98 x 33 cm	90 x 98 x 33 cm	120 x 158 x 65 cm	154 x 91 x 59 cm	137 x 92 x 48 cm
Number of compartments/shelves	12/2	1	3	8	4	4
Design	mobile book cube, with 6 Tidy Boxes on both sides and one shelf	mobile book shelf, one-sided useable with 2 sloping magazine shelves and one straight shelf	mobile book shelf, one-sided useable with 3 straight shelves	mobile book shelf, usable on both sides with 4 straight shelves	mobile, inner radius 208 cm with cover plate and side handles	mobile, inner radius 49 cm

SHELVES AND ROOM DIVIDERS



SHELVES/ROOM DIVIDERS | WOOD



DESIGN	BASIC SHELF	EXTENSION SHELF
Number of shelves	6 per side	6 per side
Dimensions W/H cm	83 x 203 cm	80 x 203 cm
Depth 34 cm	6220	6225
Depth 72 cm	6230	6235

OPTIONS		
Movable bookend (0992)	<input type="checkbox"/>	<input type="checkbox"/>
Shelf with guide groove (0638)	<input type="checkbox"/>	<input type="checkbox"/>
Magazine shelf (0644)	<input type="checkbox"/>	<input type="checkbox"/>
Labelling carrier (0652)	<input type="checkbox"/>	<input type="checkbox"/>
Labelling strip (0653)	<input type="checkbox"/>	<input type="checkbox"/>
End bracket (6220010)	<input type="checkbox"/>	<input type="checkbox"/>

SHELVES/ROOM DIVIDERS | STEEL



DESIGN	BASIC SHELF	EXTENSION SHELF	SHELF
Number of shelves	5	5	1
Dimensions W/H cm	106 x 200 cm	101 x 200 cm	W 100 cm
Depth 30 cm	6280	6285	0600
Depth 40 cm	6281	6286	0601
Depth 50 cm	6282	6287	0602
Depth 60 cm	6283	6288	0603



Shelves/room divider

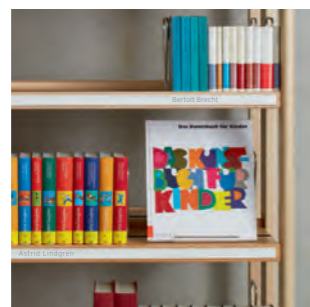

Labelling strips



Quick-adjustable bookend



Labelling carriers

* Height for mobile cabinets + 3 cm



PROPERTY LOCKERS



PROPERTY LOCKERS				
MODEL	4001.820	4003.830	4002.820	4004.820
Dimensions W/H/D	138 x 89 x 48 cm	138 x 118 x 48 cm	138 x 89 x 48 cm	138 x 89 x 48 cm
No. of compartments	6	6	9	6

PROPERTY LOCKERS					
MODEL	4005.820	4006.820	4007.820	4020.820	4015.820
Dimensions W/H/D	138 x 89 x 48 cm	138 x 89 x 48 cm	138 x 89 x 48 cm	138 x 89 x 48 cm	138 x 89 x 48 cm
No. of compartments	3	3	3	3	
Number of Tidy Boxes	8 x small	8 x small	16 x small	8 x large	16 x small, 8 x large

PROPERTY LOCKERS						
MODEL	4128.420	4128.620	4128.820	4129.422	4129.622	4129.822
Dimensions W/H/D	70 x 89 x 48 cm	104 x 89 x 48 cm	138 x 89 x 48 cm	70 x 89 x 48 cm	104 x 89 x 48 cm	138 x 89 x 48 cm
Number of Tidy Boxes	16 x small	24 x small	32 x small	8 x large	12 x large	16 x large

OPTIONS PROPERTY CABINETS
Option mobile*
Magnetic back panel
Back wall covered with cork nature

PUPIL SUBJECT SHELVES



SCHOOL SATCHEL SHELVES				
MODEL	4033.220	4033.320	4033.230	4033.330
No. of compartments	4	6	6	9
Dimensions W/H/D	70 x 121 x 49 cm	104 x 121 x 49 cm	70 x 175 x 49 cm	104 x 175 x 49 cm
Option mobile*	<input type="checkbox"/>	<input type="checkbox"/>	<input type="checkbox"/>	

PUPIL LOCKERS								
MODEL	4260.629	4261.629	4262.820	4263.820	4252.629	4253.629	4264.820	4265.820
No. of compartments	9	9	12	12	12	12	16	16
Dimensions W/H/D	90 x 89 x 42 cm	90 x 89 x 58 cm	120 x 89 x 42 cm	120 x 89 x 58 cm	90 x 89 x 42 cm	90 x 89 x 58 cm	120 x 89 x 42 cm	120 x 89 x 58 cm
Option mobile*	<input type="checkbox"/>	<input type="checkbox"/>	<input type="checkbox"/>	<input type="checkbox"/>	<input type="checkbox"/>	<input type="checkbox"/>	<input type="checkbox"/>	<input type="checkbox"/>

* Height for mobile cabinets + 3 cm

SPECIALIST CLASSROOM CABINETS



LAPTOP CABINET



MODEL	4440.200
Doors	4-door
Dimensions W/H/D	120 x 130 x 52 cm
Number of shelves	16

Design space for 16 laptops, incl. 2 Tidy Boxes, 2 x 8-way power socket with inrush current limiter, 1 x cable outlet in the back wall on the left for power supply, cable holder on the back wall on the left for winding up the power cable, castor frame with 4 double swivel castors, 2 of which are lockable, 2 furniture handles on the sides, lockable with safety lock



4440.200
Laptop cabinet



From the front, opened From behind, closed From behind, opened

INSTRUMENT CABINETS



MODEL	4444.011	4444.012	4444.850
Doors	2-door	2-door	2-door
Dimensions W/H/D	120 x 204 x 60 cm	120 x 204 x 60 cm	150 x 204 x 73 cm
Design	lockable on one side, without center panel, 2 removable shelves, 8 small compartments at bottom right	individually lockable on both sides, with center panel, 8 removable shelves, 10 small compartments on the right, container for small parts on the inside of the doors	individually lockable on both sides, with center panel, 5 removable shelves, 4 small compartments, 3 compartments on the bottom right, holders and containers on the inside of the doors

DRAWING CABINETS DIN A0

DIN A1



MODEL	1181.006	1181.008	1181.106	1181.108
Dimensions W/H/D	135 x 79 x 93 cm	135 x 98 x 93 cm	100 x 79 x 68 cm	100 x 98 x 68 cm
Number of extracts	6	8	6	8

The wooden drawing cabinets are delivered disassembled.

DRAWING CABINETS MADE OF SHEET STEEL DIN A0

DIN A1



MODEL	4182	4183	4185	4186
Powder-coated	RAL 1013 pearl white	RAL 1013 pearl white	RAL 1013 pearl white	RAL 1013 pearl white
Dimensions W/H/D	135 x 76 x 96 cm	135 x 76 x 96 cm	110 x 76 x 76.5 cm	110 x 76 x 76.5 cm
Number of extracts	8	10	8	10

SINK CABINETS



SINK CABINETS



MODEL	4438.650	4438.950	4438.850
Doors	2-door	2-door	2-door
Dimensions W/H/D	80 x 204 x 60 cm	100 x 204 x 60 cm	120 x 204 x 60 cm
Design	lockable on one side, without back wall, with trailing base and recessed bottom panel	lockable on one side, without back wall, with trailing base and recessed bottom panel	lockable on one side, without back wall, with trailing base and recessed bottom panel

WARDROBES



WARDROBE CABINETS

WITH LONGITUDINAL EXTENSION ROD

WITH TRANSVERSE CLOTHES RAIL



FH	5	5	5	5	5	5	5
Height	204 cm	204 cm	204 cm	204 cm	204 cm	204 cm	204 cm
Number of shelves	0	0	4	1	2	4	1
Center panel		■	■		■	■	
DEPTH	44 CM	44 CM	44 CM	60 CM	60 CM	60 CM	60 CM
Width 61 cm	4403.450			4404.450			
Width 80 cm			4407.650		4448.650	4408.650	4410.650
Width 100 cm		4443.950	4407.950		4448.950	4408.950	4410.950
Width 120 cm		4443.850	4407.850		4448.850	4408.850	4410.850

WARDROBE SHELVES

WITH CLOTHES RAIL CROSSWISE

WARDROBE SHELVES

WITH 3-FOLD COAT HOOK



FH	5	5	MODEL	4032.441	4032.641
Height	204 cm	204 cm	Height with base	175 cm	175 cm
Number of shelves	1	2	Dimensions W x D	70 x 48 cm	104 x 48 cm
Center panel		■	No. of compartments	4	6
DEPTH	58 CM	58 CM	Design	one compartment consisting of: Top compartment equipped with 3-fold coat hooks, bottom compartment equipped with 2 pairs of Tidy Box rails	one compartment consisting of: Top compartment equipped with 3-fold coat hooks, bottom compartment equipped with 2 pairs of Tidy Box rails
Width 61 cm	4419.450				
Width 80 cm	4419.650	4429.650			
Width 100 cm	4419.951	4429.950			
Width 120 cm	4419.850	4429.850			

OPTIONS

Tidy Box small	4 or 8 pieces	6 or 12 pieces
Tidy Box large	4 pieces	6 pieces



Hallway cabinets with top mounted cabinets provide sufficient storage space; the integrated seating niche with benches and table for primary pupils creates a cosy area for short breaks or a quiet workplace for individual or group work



Hallway cabinets in 2 widths and 3 equipment variants establish order; the seating niche with optional button pad backrest offers seating comfort in the hallway without having to adjust the escape routes

HALLWAY FURNITURE SYSTEM WITH SEATING NICHES



- flexible for different rooms and budgets
- in 5 FH and 2 different widths for 1 or 2 students
- top mounted cabinet in 1 FH or 2 FH with plenty of storage space
- carrier board material certified hardly flammable according to DIN 4102 B1
- finish white hardly flammable according to DIN 4102 B1
- cabinet-high handle strips, keep the escape route clear and are easy to grip from any height
- optionally all cabinets lockable
- in 3 different equipment variants
- with coat hook for jackets
- with Tidy Boxes optionally large and small
- small Tidy Boxes also fit under the A2S tables
- pull-out stools with non-slip foot
- base distributor for levelling
- bodies with connecting screws securely interconnected
- seating niche for primary school with 2 seating benches in TAFF B1 or ARTIFICIAL LEATHER B1 and 1 table
- Seating niche high school with a bench in TAFF B1 or ARTIFICIAL LEATHER B1, optionally with button upholstery in ARTIFICIAL LEATHER B1
- finish and material colour selection see A2S Material overview
- seating niches can also be combined with other 5 FH A2S cabinets, e.g. in the classroom or administrative area
- for individual planning also as a corner solution or with inclined roof please also contact your A2S area manager

HALLWAY CABINETS IN 3 EQUIPMENT VARIANTS FOR 1 OR 2 PUPILS



1 fixed and 3 adjustable shelves
Coat hooks and Tidy Boxes
Coat hook, Tidy Box and stool



HALLWAY FURNITURE SYSTEM	HALLWAY CABINET		TOP MOUNTED CABINET		SEATING NICHE	PRIMARY SCHOOL	SECONDARY SCHOOL
FH	5	5	5	1	2	FH	5
Width 36 cm · for 1 pupil	6670.250	6671.250	6672.250	6675.210	6675.220		6680.001
Width 48 cm · for 2 pupils	6670.950	6671.950	6672.950	6675.910	6675.920	Dimensions W/H/D in cm	144 x 203.9 x 70
Dimensions H/D in cm	203.9 x 58	203.9 x 58	203.9 x 58	40.3 x 58	78.7 x 58	Seat height in cm	38
1 fixed floor above		■	■			Bench	self-supporting
1 fixed floor below	■	■	■			Full upholstery	B1 hardly flammable, PG 2 and 4
Adjustable shelf	3					Seat upholstery thickness, W/D in cm	13.5, 65 x 40
Shelf with bottom panel	■					Back upholstery thickness, W/H in cm	6.9, 65 x 50
Coat hooks		1/2	1/2			Weight	129 kg
Tidy Box bottom large transparent		1				OPTIONS	
Tidy Boxes selectable large/small		2/0 or 1/2 or 0/4	1/0 or 0/2			Top mounted cabinet width 36 cm	4 x mod. 6675.210/6675.220
Stool			6690.200/6690.900			Top mounted cabinet width 48 cm	3 x mod. 6675.910/6675.920
Finishing side	6674.050	6674.050	6674.050	6674.010	6674.020	Sloping roof one-sided	■
Weight	61 kg/71 kg	57 kg/64 kg	70 kg/82 kg	14 kg/17 kg	25 kg/29 kg	Sloping roof corner solution	■
OPTIONS						Backrest button pad	■
Lockable	■	■	■	■	■		
Sloping roof one-sided	■	■	■	■	■		
Sloping roof on both sides	■	■	■	■	■		
Sloping roof corner solution	■	■	■	■	■		



Available in 2 sizes and 5 colours

The practical Tidy Boxes are used in many areas - whether in the hallway or in the classroom they provide the necessary order and offer plenty of space to store writing utensils, toys or private items of students.

TIDY BOXES

- in 2 sizes and 5 colours
- drawers made of saliva-proof plastic
- removable title block on the narrow side
- lengthwise and transversely insertable through circumferential handle strip
- fully recyclable
- optional: transparent lid

TIDY BOX	SMALL	LARGE	COVER
Dimensions W/H/D	31 x 7.5 x 43 cm	31 x 15 x 43 cm	30 x 1.5 x 42 cm
MODEL	<ul style="list-style-type: none"> 515267 515264 515266 515265 515263 	<ul style="list-style-type: none"> 515520 515517 515519 515518 515516 	<ul style="list-style-type: none"> 516340



Ensure order and provide plenty of storage space in cabinets



Possible for many table models



Can be individually personalized with name tags



Storage space for writing utensils, Teaching and learning materials or toys

Tidy materials can be neatly stored in the cabinet; to work, simply remove Tidy Box and slide it under the table

Sliding door cabinet and media workstation p. 115
Property cabinet p. 121
Tables p. 44
Chairs p. 16

Whether in dressing rooms or property lockers, personalizable name tags allow each student to find their own Tidy Box quickly



Plenty of space for personal items, such as shoes, as the Tidy Boxes can be cleaned easily

Hallway cabinets p. 124
Wardrobe shelves p. 123



DISPLAY CABINETS



DISPLAY CABINETS	2/3 OF THE HEIGHT SAFETY GLASS LOCKABLE ON ONE SIDE				2/3 OF THE HEIGHT SAFETY GLASS INDIVIDUALLY LOCKABLE ON BOTH SIDES		SLIDING GLASS DOORS AT THE TOP AND HINGED DOORS AT THE BOTTOM
FH	5	5	5	5	5	5	5
Height	204 cm	204 cm	204 cm	204 cm	204 cm	204 cm	204 cm
Number of shelves	4	4	4	4	8	8	4+2
Center panel					■	■	■
DEPTH	44 CM	60 CM	44 CM	60 CM	44 CM	60 CM	44 CM
Width 61 cm	4411.450	4412.450					
Width 80 cm							4355.650
Width 100 cm			4413.950	4414.950	4451.950	4452.950	4355.950
Width 120 cm			4413.850	4414.850	4451.850	4452.850	4355.850

DISPLAY CASES



5472 Display case free standing



4815 Display case for wall mounting

DISPLAY CASES	GLASS DISPLAY CASE	WALL DISPLAY CASE	POSTER DISPLAY CASE	WALL DISPLAY CASE			
Model	5472	5483	5484	5485	4810	4815	4820
Dimensions W/H/D in cm	150 x 170 x 54.5	150 x 100 x 30	150 x 100 x 7.2	200 x 100 x 7.2	100 x 100 x 15	150 x 100 x 15	200 x 100 x 15
Design	freestanding	wall mounting*	wall mounting*	wall mounting*	wall mounting**	wall mounting**	wall mounting**

*With magnetic back panel, optional back panel with coloured cork linoleum covering
 **Back wall with coloured cork linoleum covering

MAGAZINE CABINETS



MAGAZINE CABINETS		
MODEL	4399.850	4398.950
Doors	2-door	2-door
Dimensions W/H/D	120 x 204 x 44 cm	100 x 204 x 44 cm
Design	with 12 magazine flaps, with center panel at the top, bottom 2 FH 2-door, individually lockable on both sides	with 12 magazine flaps, without center panel at the top, bottom 2 FH 2-door, individually lockable on both sides

COUNTER CABINETS



COUNTER CABINETS LOCKABLE				
Height	105 cm	105 cm	115 cm	115 cm
Number of shelves	2	2	2	2
DEPTH	42 CM	58 CM	42 CM	58 CM
Width 100 cm	4605.910	4600.910	4605.950	4600.950
Width 120 cm	4605.810	4600.810	4605.850	4600.850
Info	Room divider with 2 sliding doors for secondary schools. Open at the top with 6 small compartments.			

FH = folder height
 Height specifications refer to a 10 cm high base.

TEACHER'S COMPARTMENT CABINETS



TEACHER'S COMPARTMENT CABINETS | LOCKABLE

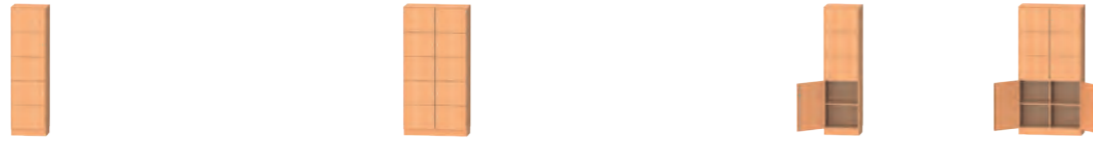

FH	5	5	5	5	5	5
Height	204 cm	204 cm	204 cm	204 cm	204 cm	204 cm
No. of teacher compartments	5	5	10	10	3	6
Number of shelves					1	2
DEPTH	44 CM	60 CM	44 CM	60 CM	44 CM	44 CM
Width 41 cm	4267.250	4268.250			4271.250	
Width 61 cm	4267.450	4268.450			4271.450	
Width 80 cm			4269.650	4270.650		4273.650
Width 100 cm			4269.950	4270.950		4273.950
Width 120 cm			4269.850	4270.850		4273.850

TEACHER'S COMPARTMENT CABINETS | WITH MAILBOXES IN THE MIDDLE



FH	5	5	5	5
Height	204 cm	204 cm	204 cm	204 cm
No. of teacher compartments	4	4	3	3
Number of mailboxes	4	4	3	3
DEPTH	44 CM	60 CM	44 CM	60 CM
Width 41 cm	4279.250	4280.250	4283.250	4284.250
Width 61 cm	4279.450	4280.450		
Info			lower 2 FH with 1 revolving door	lower 2 FH with 1 revolving door

TEACHER'S LOCKERS CABINETS | WITH MAILBOXES CENTRED | WITH CENTRE PANEL



FH	5	5	5	5	5	5	5	5
Height	204 cm	204 cm	204 cm	204 cm	204 cm	204 cm	204 cm	204 cm
No. of teacher compartments	8	8	8	8	6	6	6	6
Number of mailboxes	8	8	8	8	6	6	6	6
DEPTH	44 CM	60 CM	44 CM	60 CM	44 CM	60 CM	44 CM	60 CM
Width 61 cm	4239.450	4240.450			4287.450	4288.450		
Width 80 cm			4281.650	4282.650			4285.650	4286.650
Width 100 cm			4281.950	4282.950			4285.950	4286.950
Width 120 cm			4281.850	4282.850				
Info					lower 2 FH with 1 revolving door	lower 2 FH with 1 revolving door	lower 2 FH with 2 revolving doors	lower 2 FH with 2 revolving doors

TEACHER'S COMPARTMENTS WITH MAILBOXES UNDERNEATH

TEACHER'S COMPARTMENTS WITH LETTER SLOTS ABOVE



FH	5	5	5	5	5	5
Height	204 cm	204 cm	204 cm	204 cm	204 cm	204 cm
No. of teacher compartments	4	8	5	10	3	6
Number of mailboxes	4	8	5	10	3	6
DEPTH	44 CM	44 CM	44 CM	44 CM	44 CM	44 CM
Width 41 cm	4275.250		4291.250		4295.250	
Width 80 cm		4277.650		4293.650		4297.650
Width 100 cm		4277.950		4293.950		4297.950
Info					lower 2 FH with 1 revolving door	lower 2 FH with 2 revolving doors

MAILBOX CABINETS



MAILBOX CABINETS LOCKABLE



FH	5	5
Height	204 cm	204 cm
Number of mailboxes	24	36/36/48
Number of shelves	1	2
DEPTH	44 CM	44 CM
Width 61 cm	4477.450	
Width 80 cm		4479.650
Width 100 cm		4479.950
Width 120 cm		4479.850

KITCHENETTE CABINETS

KITCHENETTE CABINETS

SINK BASE CABINETS



MODEL	4439.852	4459.100	6354.503	6354.420
Doors	2-door	Roller shutter	1-door	1-door
Dimensions W/H/D	120 x 204 x 67 cm	124 x 204 x 64 cm	52 x 72 x 55 cm	60 x 72 x 55 cm
Design	with carrying base, lockable on one side, supplemented by sink base cabinet 6354.503 and refrigerator or dishwasher	supplemented by sink base cabinet 6354.420 and refrigerator or dishwasher	addition to 4439.852 electrical and water connection on site	addition to 4459.100 electrical and water connection on site

FH = folder height
Height specifications refer to a 10 cm high base.



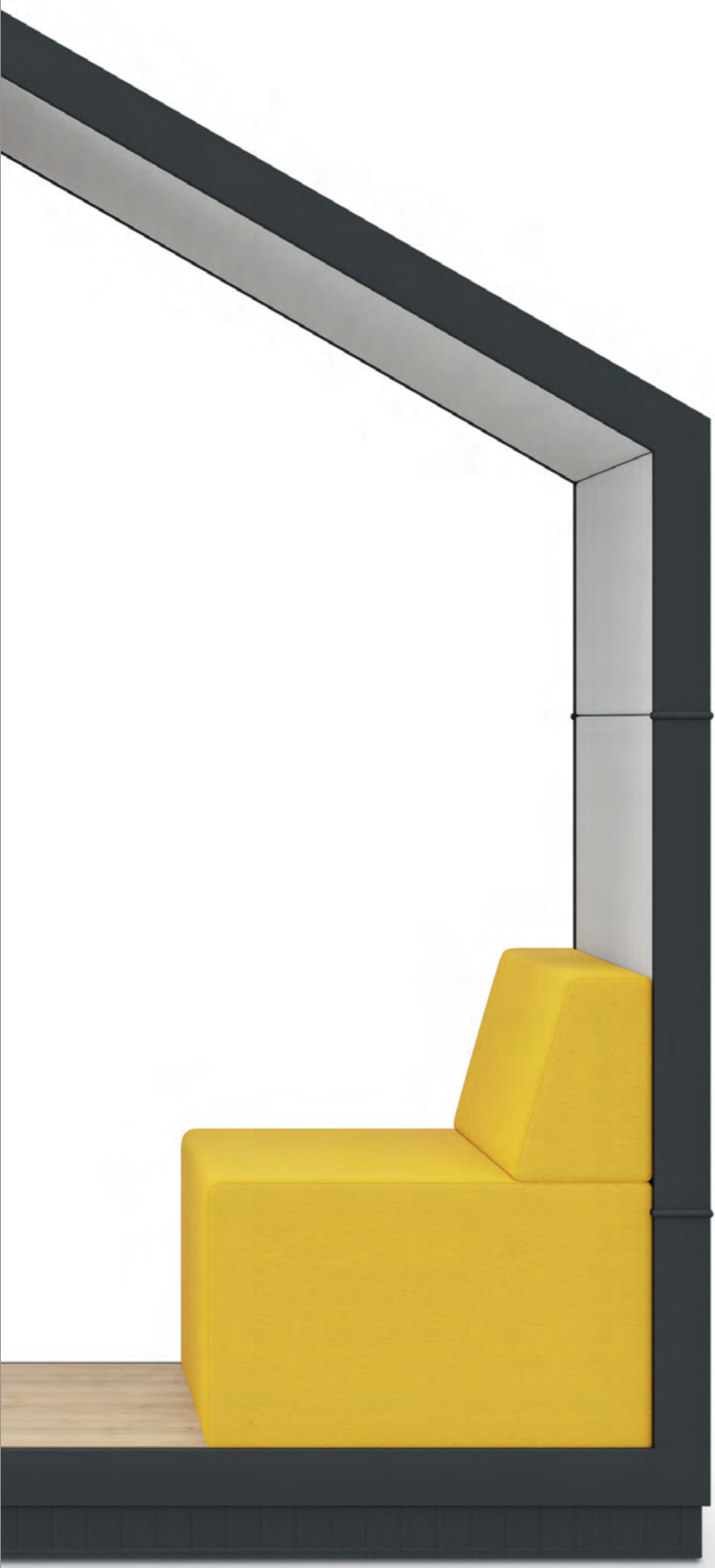

A2S LOUNGE FURNITURE | ACOUSTICS



CHILL HOUSE MEETING HOUSE 134 134 134



DOMINO MAZE 136 136 136 136 136 136



DOMINO HOUSE CYLINDA BLOC 138 139 139 139 139 139 139



MODULA SYSTEM 140 140 140 140 140 140 140 140 140 140



COMFORT HI 144 144 144



Folding couch Folding chair COCOON CHILL-Series 145 146 146 146 146 146 146 146



COMBI partition wall Decor movable wall 148 148 150 150



ACOUSTIC elements 152 152 152 152



9390.002 CHILL HOUSE WOOD
with exterior walls in natural oak



9390.001 CHILL HOUSE
with exterior walls in fabric

The CHILL House for relaxed breaks or pleasant reading, learning or exchanging. Ideally for hallways, waiting areas and auditoriums.



9390.003 MEETING HOUSE
space for 4 people, incl. table, multimedia connections and LED light
optional also with glass door and ventilation, for quiet working or undisturbed meetings

CHILL HOUSE/MEETING HOUSE

- upholstered elements with backrest: Upholstery made of foam
- height upholstered element with backrest: 68 cm
- upholstery and interior walls optional with fabric TAFF B1, WOOL or PROTEX, for colour selection see A2S material overview
- substructure of robust 3-layer chipboard
- frame construction: Metal frame with closed base powder-coated in RAL 9005 black or RAL 9010 pure white
- flooring in wooden panels natural oak

CHILL HOUSE

- exterior walls available in fabric or wooden panels natural oak, for fabric selection see A2S material overview

MEETING HOUSE

- table frame powder-coated like metal frame
- table top HPL coated, optional in white, anthracite or black
- multimedia connection: 1 x power socket, 1 x USB, 1 x HDMI
- incl. LED light
- optional with glass door and ventilation system

Your A2S area manager will be happy to advise you



	CHILL HOUSE	CHILL HOUSE	MEETING HOUSE
MODEL	9390.001	9390.002	9390.003
Dimensions W/H/D in cm	210 x 228 x 78	210 x 228 x 78	210 x 228 x 153
Seat height	33 cm	33 cm	33 cm
Interior walls fabric TAFF B1/WOOL	■	■	■
Exterior walls fabric TAFF B1/WOOL	■	■	■
Exterior walls natural oak		■	
Frame powder-coated black	■	■	
Weight	210 kg	210 kg	500 kg
Packaging note	is delivered disassembled on a pallet: W/H/D: 210 x 190 x 78 cm	is delivered disassembled on a pallet: W/H/D: 210 x 190 x 78 cm	is delivered disassembled on two pallets: 2 x W/H/D: 210 x 190 x 78 cm



The DOMINO individual modules in freely selectable colour combinations always create a pleasant atmosphere thanks to the numerous design options - whether for meetings or for small relaxation breaks.

DOMINO SERIES

DOMINO upholstered furniture brings comfort to the schoolday and provides a cosy, relaxed atmosphere. Whether for the arrangement of permanent room furnishing or as movable sitting units, the forms and colours are almost limitless.

OPTIONS.

- visual privacy by means of backrests and/or sides
- linking of modules to form seating formations
- range of colour options



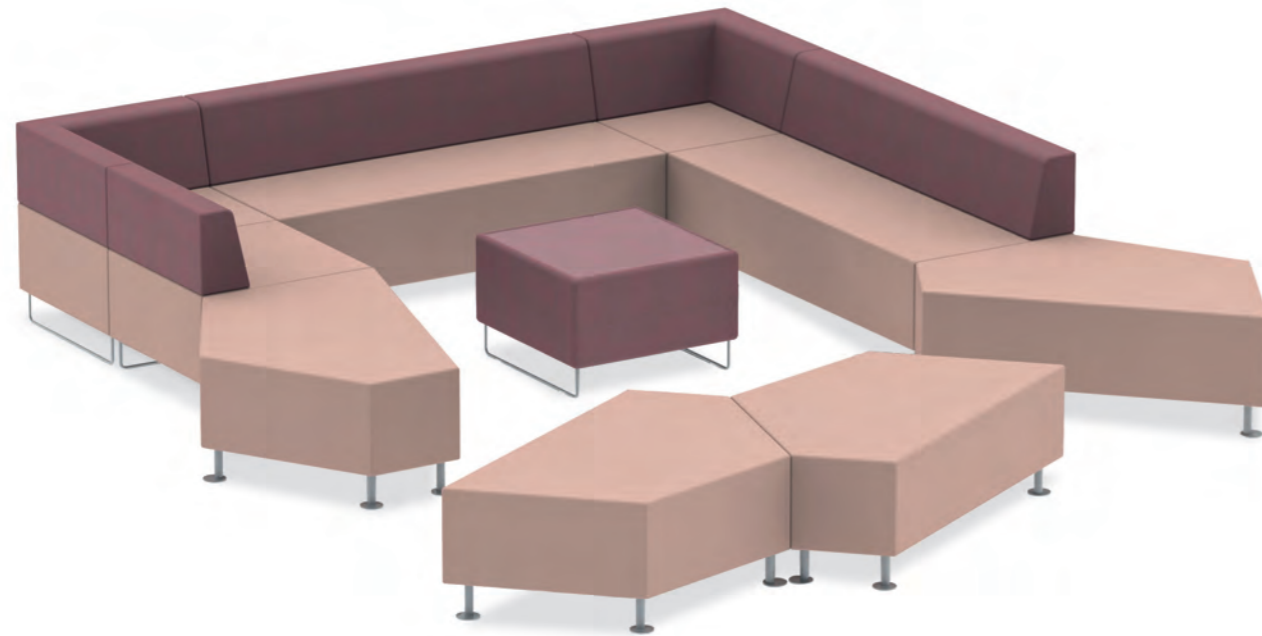





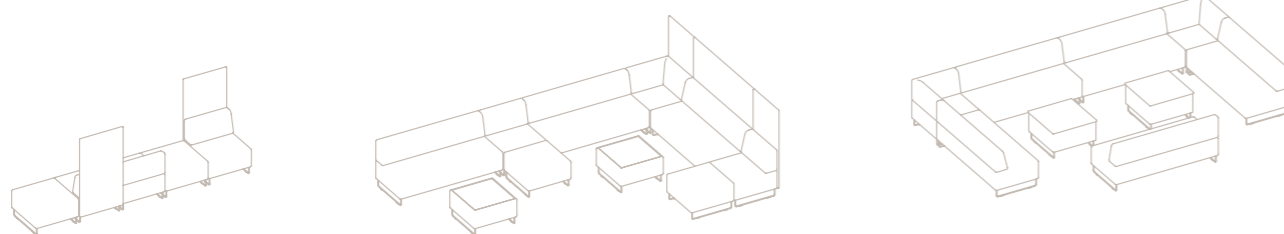

Fits together perfectly and offers numerous design possibilities: DOMINO and MAZE.
For individual planning of your seating arrangements, please contact your A2S area manager.

DOMINO AND MAZE SERIES

- robust construction and durable foams
- easy-care and hard-wearing fabrics and leather covers in a wide selection, in price group 1-4, see A2S material overview
- colour combinations freely selectable within a fabric group
- optional with hardly inflammable fabric and leather covers in B1 of price group 2 and 4, see A2S material overview
- freely combinable individual modules, useable individually or in a fixed combination
- optional privacy and noise protection on back and/or sides, only available in fabric group WOOL
- frame powder-coated in RAL 9006 chrome silver as standard or optionally chrome-plated
- table available with finish board or glass board



Combination of
9387.147 MAZE stool with backrest and
9387.002 MAZE stool supplemented by
elements of the CYLINDRA series

MODULE SYSTEM DOMINO	STOOL	STOOL WITH BACKREST	BENCH	EXTERNAL ELEMENT/ CORNER ELEMENT	ARMREST	TABLE WITH GLASS BOARD/ FINISH BOARD
						
MODEL	9384.001	9384.070	9384.165	9384.301R 9384.302L 9384.303E	9384.004	9384.003 9384.006
Dimensions W/H/D in cm	69 x 45 x 69	69 x 75 x 69	165 x 75 x 69	69 x 75 x 69	22 x 52 x 69	69 x 45 x 69
Seat height in cm	45	45	45	45		
Powder-coated frame	skids	skids	skids	skids		skids
Weight	18 kg	24 kg	48 kg	25 kg	9 kg	30 kg/22 kg

OPTIONS						
Chrome-plated frame	■	■	■	■		■
Felt floor protectors	■	■	■	■		■
Floor mounting mod. 9384.904	■	■	■	■		■
Privacy screen back wall*		9385.069	9385.165	9385.069		
Privacy screen side wall*	9385.049	9385.049	9385.049	9385.049		

*Mounted height 135 cm. Only available in fabric group Wool

MAZE	STOOL	STOOL WITH BACKREST	DOMINO PILLOW
			
MODEL	9387.002	9387.147	9384.901
Dimensions W/H/D in cm	138 x 45 x 97	138 x 75 x 97	35 x 35 x 7-9 cm
Seat height in cm	45	45	
Powder-coated frame	round tube with platform	round tube with platform	
Weight	20 kg	22 kg	0.5 kg

OPTIONS			
Chrome-plated frame	■	■	
Linking	■	■	
Floor mounting mod. 9387.904	■	■	

POSITIONING OF CORNER/
EXTERNAL ELEMENTS

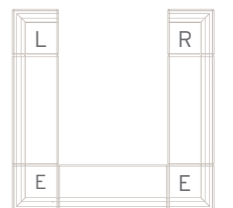

E = corner element
L = external element left
R = external element right



9385.001 DOMINO HOUSE
suitable addition to the DOMINO and MAZE Series

DOMINO SERIES | DOMINO HOUSE



- robust construction and durable foams
- frame powder-coated RAL 9006 chrome silver, optional chrome-plated
- height upholstered element with backrest: 74 cm
- upholstery element as well as interior and exterior walls optional with FLEECE, SKANDIA, TAFF B1 or WOOL fabric, for colour selection see A2S material overview
- optionally available in 3 different colours within one fabric group: seating element, interior wall and exterior wall
- equipped with coat hooks left and right, powder-coated black



Up to 3 different colours selectable within one fabric group: Seating element, interior wall and exterior wall



Equipped with one coat hook each left and right

DOMINO HOUSE



MODEL	9385.001
Dimensions W/H/D in cm	170 x 165 x 72 cm
Seat height in cm	45
Powder-coated frame	skids
Weight	115 kg

OPTIONS

Chrome-plated frame	■
Felt floor protectors	■



The colourful seating elements **CYLINDA** and **BLOC** combine comfort with maximum flexibility, even in small rooms, and are ideal in combination with our DOMINO and MAZE Series, see page 136









The seating islands of the **CYLINDA** and **BLOC** Series make diverse opportunities possible to place cosy and colourful spots.

CYLINDA AND BLOC SERIES | UPHOLSTERED STOOL



- robust construction and durable upholstery
- easy-care and hard-wearing upholstery fabrics and leather covers in a wide selection, in price group 1-4, see A2S material overview
- optional with hardly inflammable fabric and leather covers, in price group 2 and 4, see A2S material overview
- felt or plastic floor protectors
- optional with floor fixing, suitable for concrete, tile, linoleum, rubber, vinyl, metal, wood, stone, glass, etc.

	CYLINDA			BLOC		
						
MODEL	9359.045	9359.090	9359.120	9358.042	9358.069	9358.096
Dimensions W/D in cm	Ø 45	Ø 90	Ø 120	42.5 x 42.5	69.5 x 42.5	96.5 x 42.5
Seat height in cm	41	41	41	41	41	41
Weight	7.8 kg	20.4 kg	30 kg	8.4 kg	13 kg	18 kg
OPTIONS						
Floor mounting	9359.945	9359.990	9359.912	9358.942	9358.969	9358.996



With its versatile combinable elements, MODULA offers countless possibilities for the creative furnishing and zoning of open learning landscapes

MODULA SYSTEM



WORKING AND RELAXING - IN THE SAME PLACE, AT THE SAME TIME.

- sophisticated system for versatile combination possibilities and zoning
- flexibility thanks to the modular principle, can be expanded with straight DOMINO elements
- can be combined with DOMINO, MAZE, CYLINDA, BLOC as well as COMBi for more design possibilities
- robust construction and durable upholstery
- easy to care for and durable covering fabrics and leather coverings in different qualities
- extensive colour selection, freely selectable
- combinations of room dividers and soundproofing function via back panels in three different heights
- back panels optionally with a socket insert or USB charger
- Shelf elements with translucent acrylic glass back panel



No matter whether in learning rooms, quiet areas or waiting areas - the inviting open forms allow for effective dual use of the spaces (e.g. library/media library).



The fabric-covered partition walls also have an acoustic function in addition to dividing the room. In this way, silent focused work and open relaxed communication can take place simultaneously during all forms of learning and working.



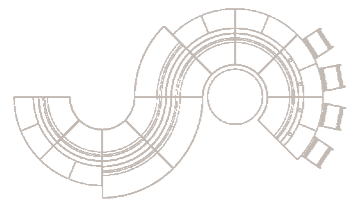
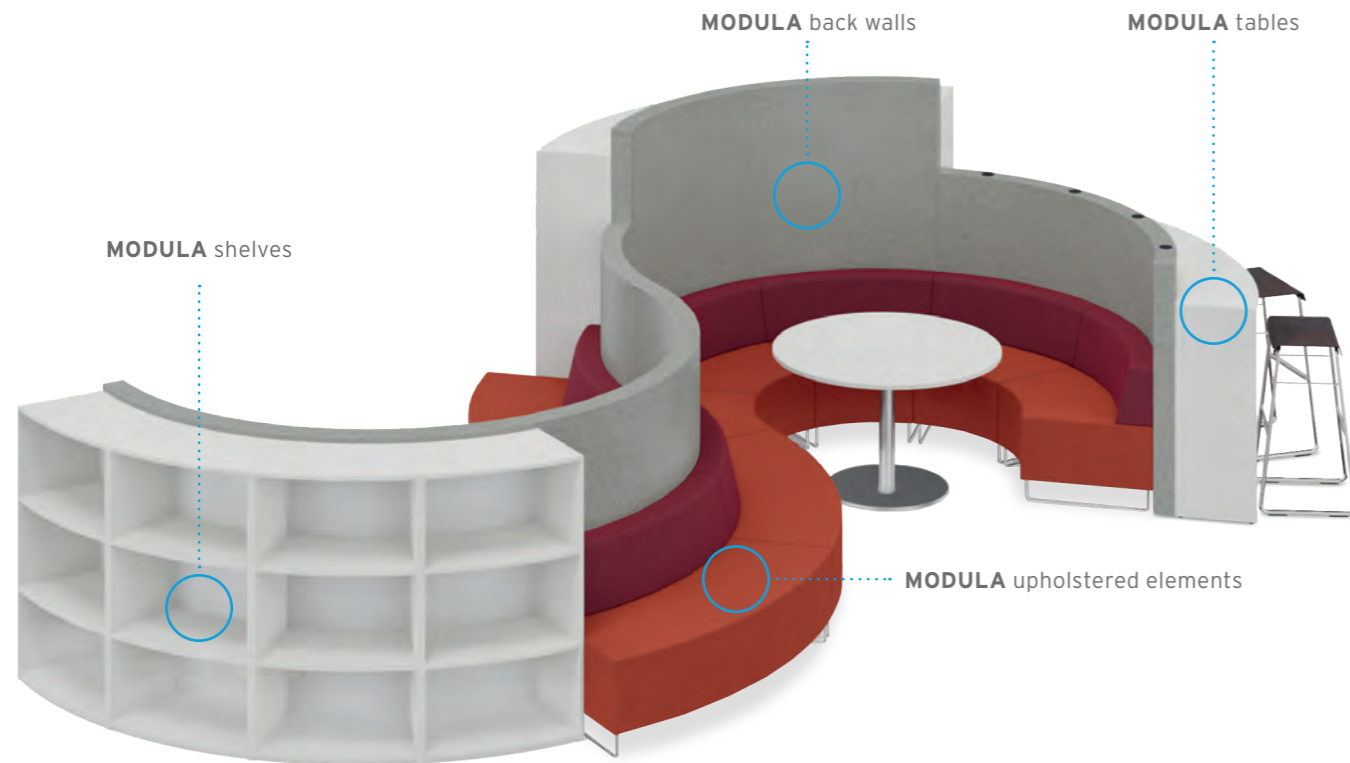

MODULA S-shape adjustment combination with
 9 x **9384.045** upholstered element 45° concave
 3 x **9384.245** upholstered element 45° convex
 5 x **9388.045** back panel curved
 2 x **9388.045** back panel curved
 incl. electrification

2 x **9389.045** back panel curved
 4 x **4620.531** shelf curved, 3 OH
 4 x **4620.541** shelf, curved, 4 OH
 4 x **3135.074** table curved
 4 x **7898** CHANGE bench 1-seater
 1 x **2006.120** circular plate base table

MODULA SYSTEM



- well thought-out system for versatile combination possibilities and zoning
- double usability: concentrated work at the table and relaxed exchange on the upholstered elements
- flexibility through modular principle, expandable with MAZE and straight DOMINO elements
- can be combined with the CYLINDA, BLOC and COMBi series for more design options



MODULA EXAMPLE COMBINATIONS

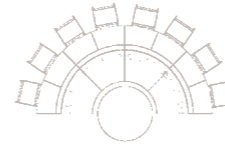

SEMICIRCLE
 4 x **9384.045** upholstered element 45° concave
 4 x **9388.045** back panel curved
 9 x **3135.074** table curved
 8 x **7898** CHANGE bench 1-seater
 1 x **2006.120** circular plate base table

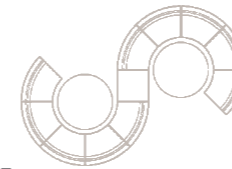
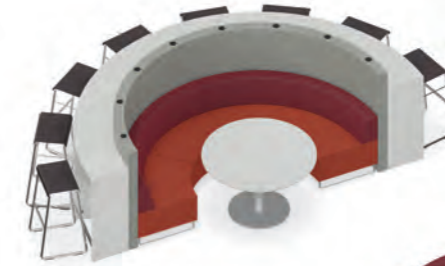

S-SHAPE
 10 x **9384.045** upholstered element 45° concave
 1 x **9384.001** DOMINO stool
 2 x **2006.120** circular plate base table



WAVEFORM
 12 x **9384.045** upholstery element 45° concave
 12 x **9388.045** back panel curved
 3 x **2006.120** circular plate base table
 6 x **9359.045** CYLINDA stool 1-seater

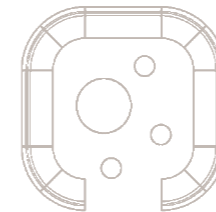
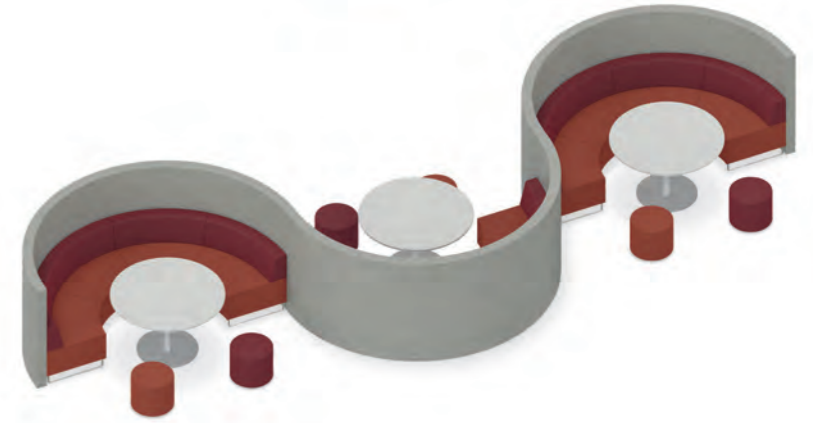

RECTANGLE
 8 x **9384.045** upholstered element 45° concave
 3 x **9384.165** DOMINO bench with backrest
 1 x **9359.090** CYLINDA stool 2-seater
 3 x **9359.045** CYLINDA stool 1-seater



THREE-QUARTER CIRCLE
 6 x **9384.045** upholstered element 45° concave
 6 x **9388.045** back panel curved
 1 x **2006.120** circular plate base table

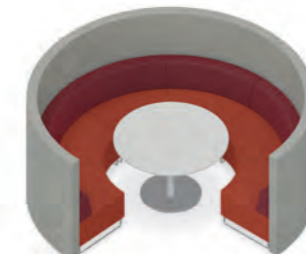

MODULA UPHOLSTERY ELEMENTS



- robust construction and durable foams
- stable skid frame powder-coated in chrome silver 9006 as standard or optionally chrome-plated
- plastic floor protectors included
- easy-care and hard-wearing cover fabrics and leather covers selectable from price groups 1-4, colours see A2S material overview
- colours of backrest and seat separately selectable within one fabric group
- optionally with flame retardant cover fabrics and leather covers in B1 from price groups 2 and 4, colours see A2S material overview
- extendable with straight DOMINO seat elements

MODULA UPHOLSTERY ELEMENTS	CONCAVE/CONVEX			STRAIGHT (DOMINO SEATS)		
MODEL	9384.045	9384.245	9384.290	9384.001	9384.070	9384.165
Dimensions W/H/D in cm	107 x 75 x 69	161 x 75 x 69	182 x 75 x 69	69 x 45 x 69	69 x 75 x 69	165 x 75 x 69
Seat height in cm	45	45	45	45	45	45
Segment angle	45°	45°	90°			
Powder-coated frame	skids	skids	skids	skids	skids	skids
Weight	19 kg	37 kg	36 kg	18 kg	24 kg	48 kg
OPTIONS						
Chrome-plated frame	■	■	■	■	■	■
Felt floor protectors	■	■	■	■	■	■
Floor mounting mod. 9384.904	■	■	■	■	■	■



MODULA shelves with translucent acrylic glass back panel



MODULA back panels optionally with socket insert or USB port

MODULA BACK WALLS



- sturdy wooden frame construction with fabric covering, incl. pre-assembled connecting elements
- curved back walls bent at a 45° angle
- including floor protectors with level compensation for levelling out uneven floors
- easy-care and durable cover fabrics from fabric groups TAFF B1, WOOL or ARTIFICIAL LEATHER B1 selectable, colours see A2S material overview
- use as room divider with sound insulation function, available in 3 different heights
- back walls in heights 95 cm and 130 cm optionally with 230 V socket insert and/or USB port, cable supply 2 m
- straight back walls can only be combined with matching seating elements of the DOMINO series
- curved back panels can only be combined with matching seating elements of the MODULA series

MODULA BACK WALLS	CURVED			STRAIGHT					
MODEL	9389.045	9388.045	9383.045	9389.165	9389.069	9388.165	9388.069	9383.165	9383.069
Dimensions W/H in cm	115 x 180	115 x 130	115 x 95	165 x 180	69 x 180	165 x 130	69 x 130	165 x 95	69 x 95
Depth in cm	11	11	11	11	11	11	11	11	11
Segment angle	45°	45°	45°						
Weight	38 kg	31 kg	23 kg	48 kg	30 kg	39 kg	23 kg	30 kg	16 kg
OPTIONS									
Electric insert round		2 pieces	2 pieces			2 pieces	1 piece	2 pieces	1 piece
Socket o. USB port									

MODULA SHELVES AND TABLES



- corpus and shelves mitered made of robust 3-layer chipboard (E1) and firmly glued, melamine coated, with 2 mm plastic edge, thickness 19 mm
- only available in decor pure white U400
- shelving elements with translucent acrylic glass back panel, thickness 3 mm
- curved shelves and tables bent in 22.5° angle
- tables with footrest, chrome-plated
- including floor protectors with level compensation to compensate for uneven floors

MODULA	SHELVES CURVED		SHELVES STRAIGHT				TABLE CURVED	TABLE STRAIGHT	
MODEL	4620.541	4620.531	4610.542	4610.532	4610.541	4610.531	3135.074	3130.084	3130.064
FH	4	3	4	3	4	3			
Dimensions W/H in cm	75 x 166	75 x 127	83 x 166	83 x 127	69 x 166	69 x 127	75 x 166	83 x 166	83 x 127
Depth in cm	42	42	42	42	42	42	42	42	42
Segment angle	22.5°	22.5°					22.5°		
Weight	41 kg	33 kg	44 kg	35 kg	39 kg	31 kg	27 kg	32 kg	28 kg

FH = folder height





The high backrest elements of the lounge system Comfort Hi serve as a room divider and thus create an island of tranquillity

COMFORT SERIES | COMFORT HI

WORK MORE COMFORTABLY AND RELAX MORE EFFECTIVELY.

Our lounge furniture system Comfort Hi, due to its high backrests, offer a multitude of possibilities to create visual privacy and noise insulated islands of peace in the middle of lively, spacious areas such as hallways, entrance areas or waiting zones. That is, however, not a reason to laze about, since the possibility of media connections can be made use of as free work stations.



Upholstered furniture brings comfort to the schoolday and provides a cosy, relaxed atmosphere



OPTIONS.

- visual privacy by means of backrests and/or sides
- media connections in seating area
- linking of modules to form seating formations
- range of colour options

Electrical sockets integrated into the modular lounge system Domino allow you to work in a relaxed environment

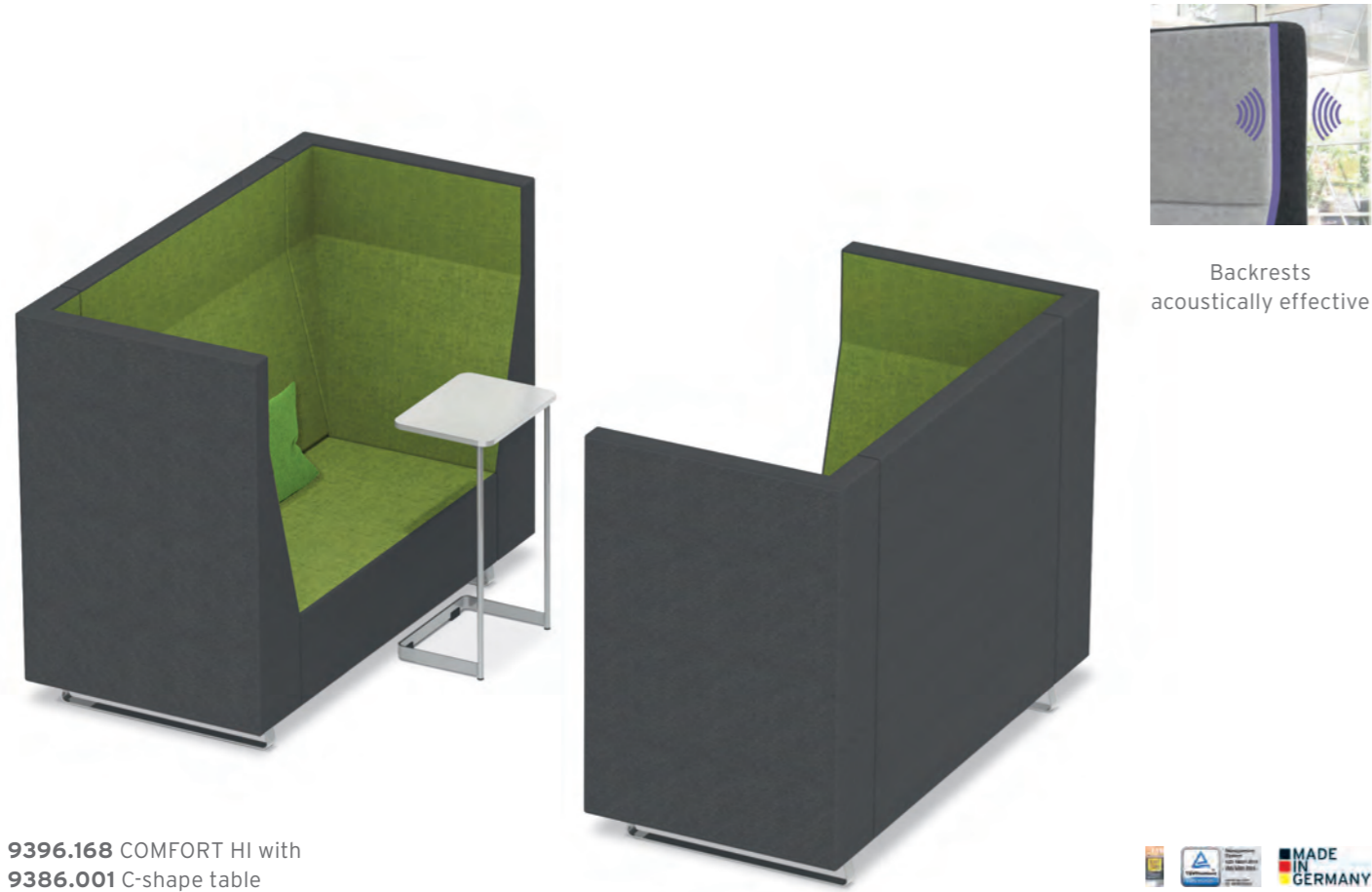





9396.168 COMFORT HI with 9386.001 C-shape table

COMFORT SERIES | COMFORT HI

- flat skid frame optionally chrome-plated or powder-coated in RAL 9006 chrome silver
- robust construction and durable upholstery
- easy-care and hard-wearing fabrics and leather covers in the fabric groups 1-4 in a wide selection, see A2S material overview
- colour combinations freely selectable within a fabric group
- optionally with hardly inflammable covers, B1 in price group 2 and 4, see A2S material overview
- COMFORT HI with high backrests is a room divider and absorbs sound

LOUNGE TABLES

- chrome-plated frame
- table top with multi-layer melamine resin coating, therefore scratch- and impact-resistant and glare-free
- as standard, we supply the table with a 3 mm plastic edge in the colour of the table top, see A2S material overview
- optional edge with 40 mm corner radius

UPHOLSTERED FURNITURE COMFORT HI	1-SEATER	2-SEATER	3-SEATER	LOUNGE TABLES*	
					
MODEL	9396.105	9396.168	9396.223	9386.001	9386.137
Dimensions W/H/D in cm	108 x 132 x 82	171 x 132 x 82	225 x 132 x 82	46 x 73 x 34	130 x 53 x 70
Seat surface W/D in cm	58 x 59	121 x 59	175 x 59		
Seat height in cm	44	44	44		
Chrome-plated frame	flat skids	flat skids	flat skids	C-shape	flat skids
Frame RAL 9006	■	■	■	■	
Weight	64 kg	86 kg	108 kg	6 kg	26 kg

* more lounge tables can be found at the plate foot tables on page 83





Folding couch and armchair for sitting, lounging, sleeping - just in case

FOLDING ARMCHAIR AND COUCH

- a must for every all-day room with durable, 21 cm thick PUR foam core (hardness 35/45) - withstands even heavy use
- upholstery fabric TAFF B1 flame-resistant or PROTEX with antibacterial surface, water-repellent and easy to wipe off, colours see A2S material overview
- cover easy to remove through the zip
- by folding out you get a lying surface of 180 x 176 cm (couch) or 80 x 180 cm (folding armchair)



5005.005 Folding armchair

	FOLDING ARMCHAIR	FOLDING COUCH
		
MODEL	5005.005	5005.001
Dimensions W/H/D in cm	80 x 71 x 80	180 x 71 x 88
Seat height in cm	42	42
Lying surface in cm	80 x 180 x 21	180 x 176 x 21
Weight	12 kg	30 kg



Like a cocoon, the **COCOON** offers a feeling of security and comfortable seating. The half-height back wall seals off the acoustics and makes the COCOON the ideal retreat for relaxed reading, looking at books or simply chilling out.

5012 | COCOON UPHOLSTERED SEATING ELEMENT WITH BACK WALL

- robust construction and durable foams
- easy-care and hard-wearing cover fabrics, standard from fabric group PROTEX or optional choice of WOOL or ARTIFICIAL LEATHER B1 fabric groups, colours see A2S material overview
- plastic floor protectors included
- colours of back and seat separately selectable within one fabric group
- seat height suitable for elementary school
- the semicircular back wall serves as sight and sound protection

CHILL SERIES | BEANBAGS/STOOL/CUSHION

- cover easily removable by zip
- fabrics washable or wipeable
- available in three different fabrics: OX, NORDIC or OUTSIDE, for colour selection and material properties see A2S material overview
- beanbag with handle for easy carrying
- inner bag with safety zip
- filling of polystyrene beads, hardly inflammable, certified according to DIN 4102 B1
- beanbag in combination with stool to put up the feet
- stool and seat cushion not only for CHILL landscapes but also ideal for the seating circle

CHILL SERIES | SEAT CUSHION







- cover easily removable by zip
- fabrics washable or wipeable
- available in three different fabrics: OX, NORDIC or OUTSIDE, for colour selection and material properties see A2S material overview
- foam core
- as upholstery for benches and also ideal for the seating circle on the floor



Whether a combination of a cozy **beanbag** and a soft **stool** to rest your feet on, or a comfortable lounge-landscape of large **reclining cushions** - with our **CHILL** models, small oases of well-being can be created in no time at all for everyday school life.

The particularly hard-wearing and waterproof fabric OX is recommended for primary school, which also matches the colour scheme of the primary school very well.

For a more homely atmosphere and comfortable haptic, we recommend the fabric NORDIC, which can be easily integrated with the fabric groups 1-4 in thought out colour concepts for secondary schools.

COCOON UPHOLSTERED SEATING ELEMENT WITH BACKREST	CHILL BEANBAG	CHILL BEAN-BAG JUNIOR	CHILL STOOL	CHILL STOOL JUNIOR	CHILL COUCH CUSHION	CHILL SEAT CUSHION	
							
MODEL	5012	5030.045	5030.035	5033.040	5032.035	5031.001	5034.001
Dim. W/H/D in cm	98 x 115 x 89	78 x 100 x 86	65 x 70 x 68	45 x 40 x 45	Ø 35 x 35	160 x 27 x 120	Ø 35 x 5
Seat in cm	Ø 80						
Seat height in cm	36	45	35	40	35	k.a.	5
Weight	35 kg	5.5 kg	3.3 kg	2.5 kg	0.9 kg	7.9 kg	
Use	primary schools	secondary schools	primary schools	secondary schools	primary schools	primary schools	primary schools



Due to their height of 1.42 m, the fabric-covered, mobile acoustic walls allow quiet work, without impairing the view of the room

COMBI SERIES | ACOUSTIC PARTITION WALL

STAYING IN THE ROOM - LEAVING THE BACKGROUND NOISE BEHIND.

The COMBi system is not a fixed room design, but a living, extendible room concept. As lively and flexible as teaching and the school routine, as fast as a spontaneous idea. The combination of a privacy screen and an acoustic element allows the eyes and ears to relax, and the wide range of colours gives any room the desired atmosphere. And the best thing is: if the room design looks different to how you imagined it, it can be changed in a trice at any time.



THE NAME SAYS IT ALL.

The name COMBi is a play on the English terms "honeycomb" and "combination". Therefore, it stands both for the striking shape of the furniture system and for its versatile use.



COMBi can be integrated into a wide variety of rooms and environments. The walls can be connected without tools and are easy to move due to castors. In conjunction with other furniture from the A2S furniture system, it is possible to constantly create new workstations and seating options for every occasion.



COMBI acoustic partition walls:
The right soundscape for healthy learning and working.

COMBI SERIES | ACOUSTIC PARTITION WALL

- acoustically effective honeycomb board as core
- available in the easy-care and hard-wearing fabrics TAFF B1 and WOOL, colour selection see A2S material overview
- optional with electrical set with sockets, also available for retrofitting
- simple and versatile combinable system for all types of work
- flexible zoning and design of rooms and inviting relaxation areas
- levelling feet powder-coated RAL 9006 chrome silver, optionally also available with castors



Triangular table
1003.118
110 x 80 cm



Trapezoidal table
1004.147
140 x 70 cm



Classroom table
7210
70 x 55 cm



Group table
1001.088
80 x 80 cm



Group table
1001.077
70 x 70 cm



COMBI Acoustic movable walls in combination with **1004.147** trapezoidal tables for quiet working areas and **9387.147** MAZE as an island of rest



Up to four walls can be connected at different angles without tools.



Powder-coated adjustable feet in chrome silver, optionally available with castors



COMBI ACOUSTIC PARTITION WALLS



MODEL	6710.070	6710.090
Dim. W/H/D in cm	70 x 142 x 8	90 x 142 x 8
Weight	15 kg	19 kg

OPTIONS

Felt floor protectors	■	■
Castors	■	■
Electrical kit	6711.071	6711.091



6701 Decor movable wall



6702 Decor movable wall with rollers



Surface optionally covered with cork natural or cork linoleum



Surface optionally magnetic and writable with whiteboard pens

DECOR PARTITION WALLS

- surface made of decor
- optionally surface covered with natural cork or cork linoleum
- optionally with writable, magnetic board surface made of white steel enamel

MODEL 6701

- frame made of round steel tube, Ø 30 x 2 mm, with screwed crossbars
- cantilever with plastic floor protectors or optionally with castors

MODEL 6702

- frame made of rectangular and round steel tube, 50 x 30 x 2 mm/Ø 30 x 2 mm
- cantilever with braked double castors
- partitions can be linked together by means of a plug-in connection



6702 Decor partition walls can be linked together, at the same time free movement of individual elements in the angle up to 120°





6701 Decor partition walls for storage can be plugged into each other to save space



6701 Decor movable wall cantilever optionally with rollers



6702 Decor movable wall cantilever including braked double castors

DECOR PARTITION WALLS	FIXED	MOBILE
		
MODEL	6701	6702
Dim. W/H/D in cm	110 x 191 x 75	110 x 195 x 66
Weight	50 kg	50 kg
OPTIONS		
Felt floor protectors	■	
Castors	■	



6714.001/6714.002 Acoustic elements freestanding muffle noises, placeable in the room as required



Up to 5 pieces can be pushed into each other to save space

LEAF-SHAPED ACOUSTIC ELEMENTS

- acoustically effective fabric-coated chipboard with leaf shape
- available in the material groups FELT or WOOL, colour selection see A2S material overview
- elements in different colours can be selected within a material group

FREESTANDING

- flexible zoning and pleasant design of rooms and relaxation areas depending on the situation
- for space-saving storage, can be pushed into each other up to max. 5 pieces

WALL-MOUNTED



- sets in two different sizes
- for wall mounting by means of a running rail per element for hanging incl. locking device

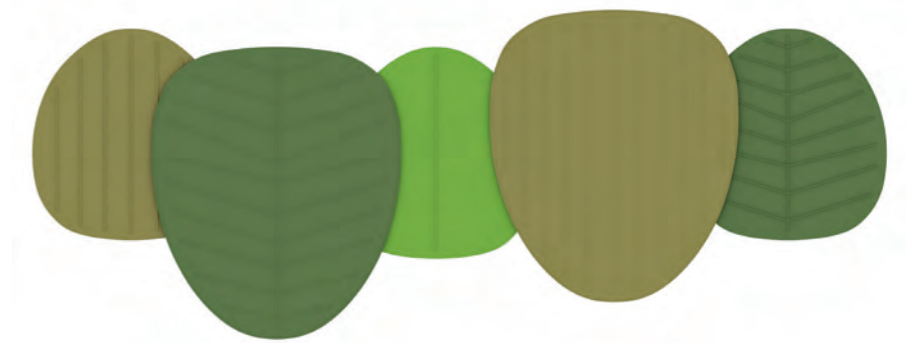

6715.001/6715.002 The wall-mounted 3- and 5-part acoustic elements ensure pleasant acoustics and, thanks to their leaf shape, a natural atmosphere even during large meetings.



6715.001 Acoustic elements wall-mounted 5-piece set

ACOUSTIC ELEMENTS	FREESTANDING		WALL-MOUNTED	
				
MODEL	6714.001	6714.002	6715.001	6715.002
Dimensions W/H/D in cm	106 x 138.5 x 3/60	133 x 177.5 x 3/60	2 x: 106 x 113 x 3 1 x: 133 x 161 x 3	3 x: 106 x 113 x 3 2 x: 133 x 161 x 3
Frame powder-coated black	■	■		
Weight	16 kg	27 kg	41 kg	72 kg



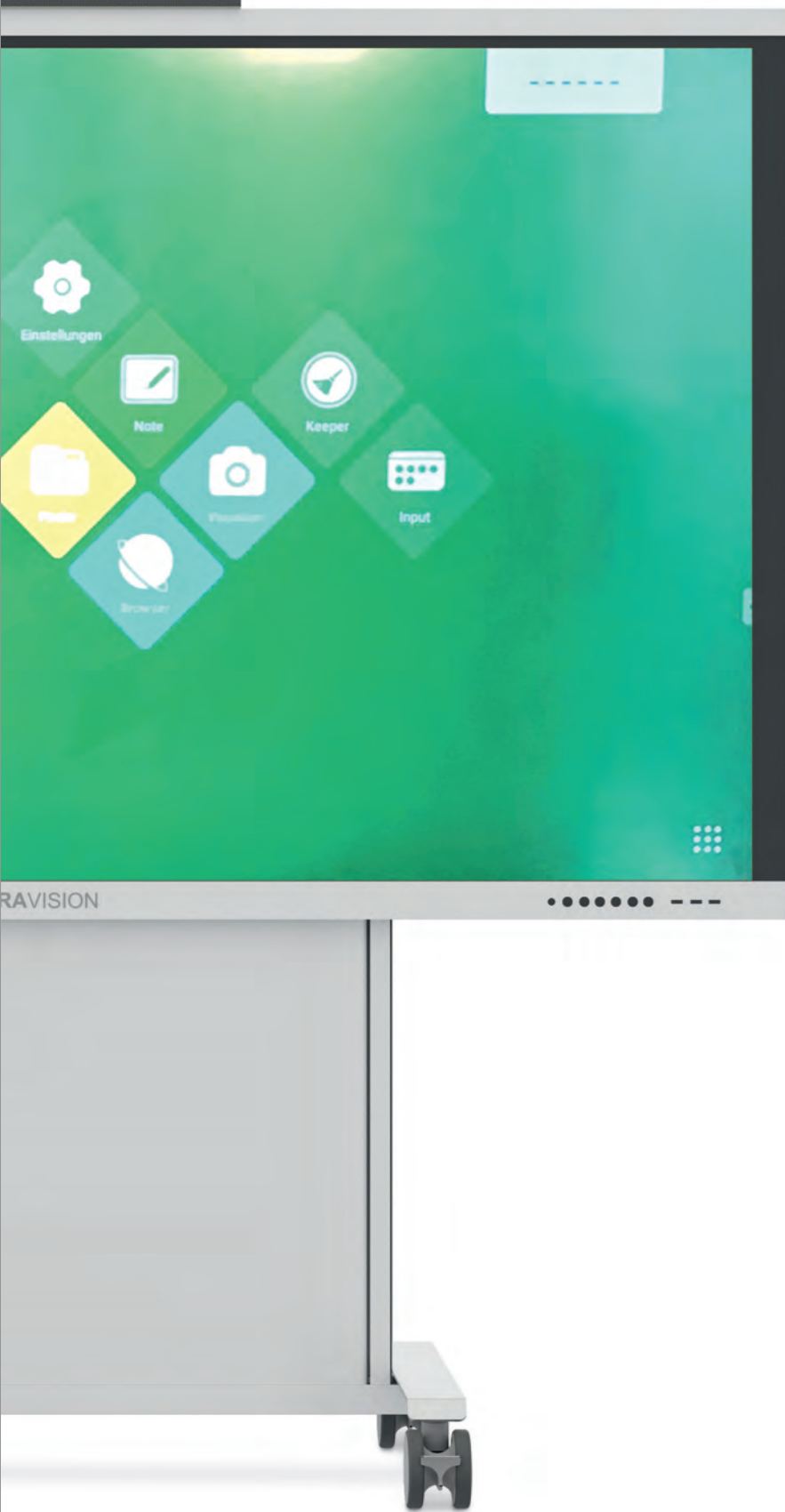

A2S BOARDS



Multifunctional board system 156



Display 158

158

158



Digital boards 160

160

160



Long wall boards 162



Sliding boards 163

163



Pylon boards 164

164

164

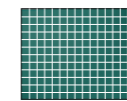

Bogie boards
Rulings
Accessories

166

167

167

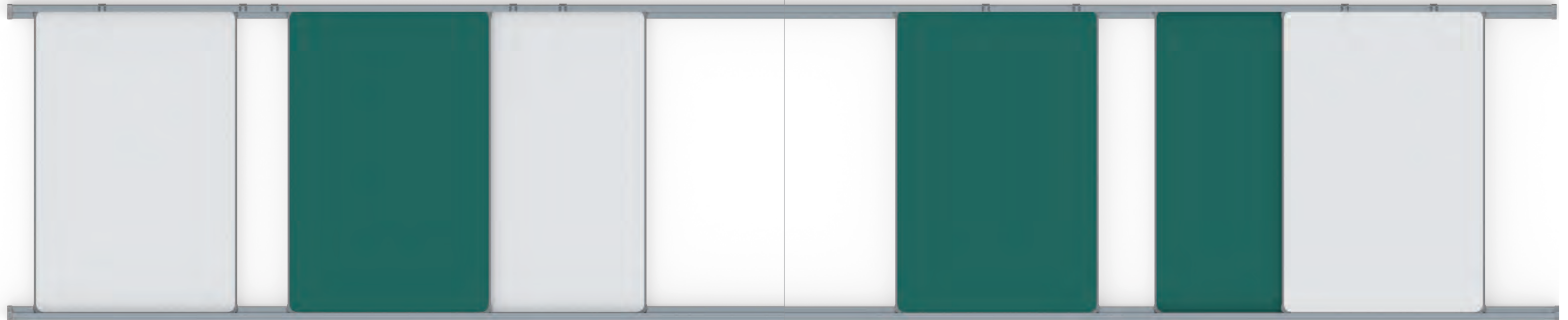

White sheet steel magnetic for whiteboard pens

Green sheet steel magnetic for chalk

The boards can be used in portrait and landscape format (different rail spacing)

The boards can be removed from the rails: ideal for group work on the site

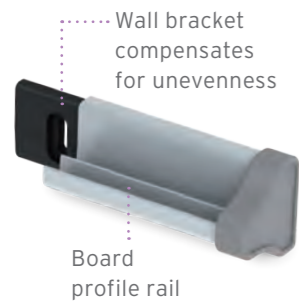

The A2S aluminium guide with robust plastic end caps is simply mounted on the wall bracket

MULTIFUNCTIONAL BOARD SYSTEM

- the board elements are particularly light and available in the sizes 90 x 60 cm and 120 x 80 cm
- the edging of the board elements is waterproof, the corners are rounded
- the working surfaces of the board elements in sandwich construction can be equipped as required, e.g. magnetic enamelled sheet steel in green or white
- the aluminium guide is robust, the fastening is invisible, the ends of the profile are enclosed by plastic caps
- board system can also be mounted on cabinet walls, info p. 115





The elastic ASSODUR® Edging strip protects the edges from impacts, e.g. when dropping



The lightweight board elements can be easily removed from the board profile rails, but are secured against accidental ejection



Sliding picture clamps with integrated gallery hook can be used in the upper aluminium guide

	SHEET STEEL GREEN		SHEET STEEL WHITE		SHEET STEEL GREEN/WHITE	
						
Dimensions	H 90	H 120	H 90	H 120	H 90	H 120
W 60 cm	6814 221		6814 321		6814 921	
W 80 cm		6814 223		6814 323		6814 923
OPTIONS						
Picture clamp (cannot be retrofitted)	■	■	■	■	■	■
Board profile rails 6872*	■	■	■	■	■	■

*Length individually adjustable, for exact planning please contact your A2S area manager



DVmobil
useable in different classrooms

DISPLAY | DURAVISION

- display made of tempered glass (ESG) glare-free with touch sensor
- resolution 3.840 x 2.160 pixels (UHD)
- display aspect ratio 16:9
- 2 integrated 12 W speakers
- integrated CPU: Android 5.1, Quad Core 450 MP, 2 GB RAM, 16 GB SSD, LAN, WIFI plug-in module, Wireless Mirroring Win, Mac, Android
- optional with plug-in PC and audio system



compatible with all operating systems



DVpylone
with two board wings writeable on both sides, adjustment range up to 140 cm, with integrated storage strip

DVcompact
height adjustable
optional with electrical height adjustment

DURAVISION	COMPACT	MOBIL	PYLONE
MODEL	DVcompact	DVmobil	DVpylone
Dimensions W/H/D	75" (176 x 103 x 10 cm) 86" (199 x 118 x 10 cm)	75" (176 x 103 x 10 cm) 86" (199 x 118 x 10 cm)	75" (176 x 103 x 10 cm) 86" (199 x 118 x 10 cm)
Design	wall-mounted height adjustable	mobile height adjustable	wall-mounted height adjustable lateral, foldable board wings with 4 writing surfaces pylon height 270 cm
Adjustment range	up to 60 cm	up to 60 cm	total pylon height
OPTIONS			
Plug-in PC	■	■	■
Audio system	■	■	■
Electrical height adjustment	■	■	

Bright ultra-short distance beamer for very good readability in all lighting conditions



Highly robust steel enamel surface for everyday school life. The sensor reacts pixel-precisely and without delay



Writing surface with rounded plastic "security corners"

Edges with aluminium profiles processed waterproof

Maintenance-free height adjustment, adjustment range: up to 70 cm

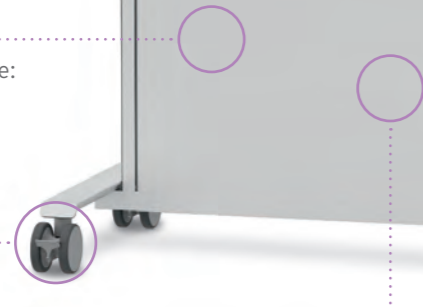

Firm stand due to heavy-duty castors, lockable in 2 positions



Storage strip integrated into the board, which keeps your hands free when needed

All electrical elements are safely stowed away; only the power supply cable is visible from outside

DBmobil
useable in different classrooms

DIGITAL BOARDS | DURABOARD

- system incl. whiteboard (200 x 120 cm) and ultra-short distance beamer
- optional with computer or audio system
- optional with remote control of the board via tablet
- for permanently mounted systems optionally with board wing
- intuitive to use



compatible with all operating systems



DBpylone
with two board wings writeable on both sides, adjustment range up to 140 cm



DBcompact
height adjustable, with integrated storage strip



The document camera (optional) transmits the image directly to the board



Optional with remote control of the board via tablet



The detection of pen movements is purely optical. No electromagnetic radiation, no exposure

DURABOARD	COMPACT	MOBILE	PYLONE
MODEL	DBcompact	DBmobil	DBpylone
Dimensions	200 x 120 cm	200 x 120 cm	200 x 120
Design	wall-mounted height adjustable	mobile height adjustable	wall-mounted height adjustable folding side wings
Adjustment range	up to 70 cm	up to 70 cm	up to 140 cm
optional: Board wings (except mobile board), audio system, integrated computer, software			

BOARD ACCESSORIES
Audio system, response system, tablet and document camera complement the digital board system and expand the possibilities for use and learning.

Ask your A2S field service.



Long wall board Magnetic sheet steel green
Ruling optional, see page 167



Available in 4 different surfaces



Picture clamping strip optional



Writing surface with rounded "safety corners";
profile covers firmly screwed on

LONG WALLBOARDS

- for wall mounting with and without storage strip
- due to the sandwich construction different surfaces are possible
 - enamelled, magnetic steel sheet in green or white
 - 4 mm thick cork coating
 - 6 mm thick cork linoleum coating in 4 different colours, see A2S material overview
- the edges of the writing surfaces are glued waterproof with natural anodised aluminium profiles
- the corners are protected with rounded plastic caps

ATTENTION!
Wall mounting of long wall boards is only possible with solid walls; with lightweight walls only with load distribution frames.

Dimensions	SHEET STEEL GREEN			SHEET STEEL WHITE			CORK COATING		CORK LINOLEUM COATING	
	H 100	H 120	H 150	H 100	H 120	H 150	H 100	H 120	H 100	H 120
W 100 cm	6810 201			6820 301			6830 501		6815 401	
W 120 cm	6810 202			6820 302			6830 502		6815 402	
W 150 cm	6810 203	6810 204		6820 303	6820 304		6830 503	6830 504	6815 403	6815 404
W 200 cm	6810 205	6810 206		6820 305	6820 306		6830 505	6830 506	6815 405	6815 406
W 250 cm	6810 207	6810 208		6820 307	6820 308		6830 507	6830 508	6815 407	6815 408
W 300 cm	6810 209	6810 210	6810 213	6820 309	6820 310	6820 313	6830 509	6830 510	6815 409	6815 410

OPTIONS										
Storage strip	incl.	incl.	incl.	■	■	■	■	■	■	■
Picture clamping strip	■	■	■	■	■	■	■	■	■	■



Hinged sliding board floor/wall mounting



Folding sliding panel floor/wall mounting
optional mobile



Single surface sliding board



Stop of end position by metal springs with rubber buffer

SLIDING BOARDS

- robust welded steel construction, scratch-resistant powder-coated
- maintenance-free, low-noise precision guide on 8 polyamide rollers with ball bearings
- aluminium guide rail
- sprung steel counterweights
- incl. storage strip and sponge container
- version optionally free standing or mobile

SINGLE SURFACE SLIDINGBOARD FLOOR/WALL MOUNTING

Dimensions	SHEET STEEL GREEN			SHEET STEEL WHITE		
	H 100	H 120	H 150	H 100	H 120	H 150
W 200 cm	6843 205	6843 206	6843 211	6843 305	6843 306	6843 311
W 250 cm	6843 207	6843 208	6843 212	6843 307	6843 308	6843 312
W 300 cm	6843 209	6843 210	6843 213	6843 309	6843 310	6843 313

optional: mobile version, free-standing version, floor mounting

HINGED SLIDINGBOARDS FLOOR/WALL MOUNTING

SHEET STEEL GREEN	
H 100	H 120
6840 205	6840 206

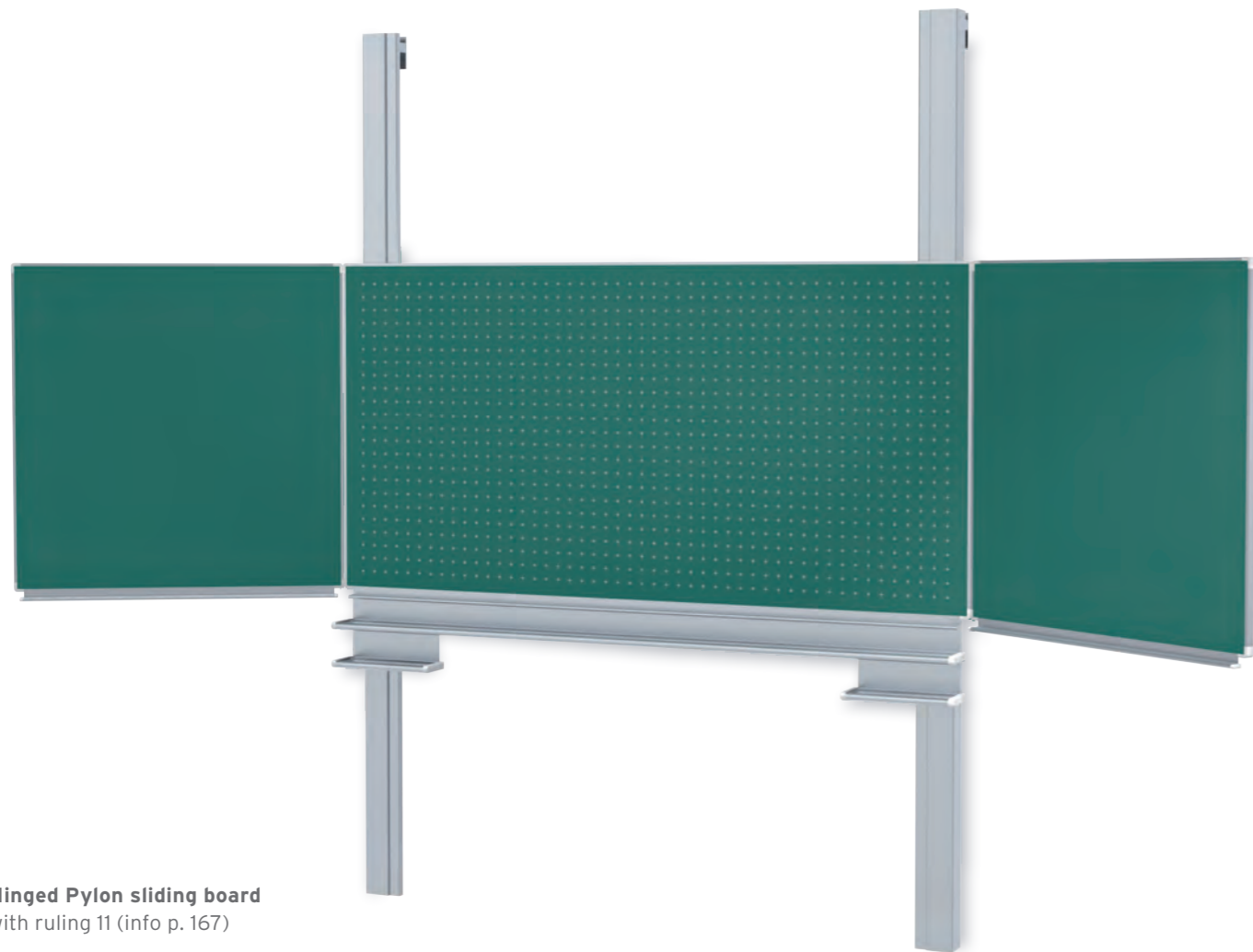

Hinged Pylon sliding board
with ruling 11 (info p. 167)

PYLON BOARDS



- robust aluminium column guide, wall mounting
- maintenance-free and low-noise precision guide on 8 polyamide rollers with ball bearing
- incl. storage strip and sponge container
- working surface made of enamelled, magnetic sheet steel in green or white
- waterproof processed edge trim with rounded corners
- rulings optional for green or white board surfaces

HINGED PYLON SLIDING BOARD

	SHEET STEEL GREEN			SHEET STEEL WHITE		
Dimensions	H 100	H 120	H 150	H 100	H 120	H 150
W 200 cm	6850 205	6850 206	6850 211	6850 305	6850 306	6850 311
W 250 cm	6850 207	6850 208		6850 307	6850 308	

incl. storage strip and sponge container



Pylon double sliding board
incl. storage strip and sponge container
for wall mounting



Pylon single-surface sliding board
incl. storage strip and sponge container
for wall mounting



Storage strip and sponge container



Rulings optional for green or white boards (info p. 167)



The accessories adhere magnetically to the sheet steel board surface

PYLON DOUBLE SLIDING BOARD

	SHEET STEEL GREEN			SHEET STEEL WHITE			SHEET STEEL GREEN			SHEET STEEL WHITE		
Dimensions	H 100	H 120	H 150	H 100	H 120	H 150	H 100	H 120	H 150	H 100	H 120	H 150
W 200 cm	6854 205	6854 206	6854 211	6854 305	6854 306	6854 311	6853 205	6853 206	6853 211	6853 305	6853 306	6853 311
W 250 cm	6854 207	6854 208	6854 212	6854 307	6854 308	6854 312	6853 207	6853 208	6853 212	6853 307	6853 308	6853 312
W 300 cm	6854 209	6854 210	6854 213	6854 309	6854 310	6854 313	6853 209	6853 210	6853 213	6853 309	6853 310	6853 313
W 400 cm	6854 214	6854 215	6854 216	6854 314	6854 315	6854 316	6853 214	6853 215	6853 216	6853 314	6853 315	6853 316

incl. storage strip and sponge container



Swivel board
incl. storage bar and sponge container



Magnetic writing surface can be rotated 360° and locked

SWIVEL BOARD

- with mobile, stable tubular steel frame and 4 swivel castors, universally applicable
- the 360° horizontally rotating writing surface can be locked in any position and is magnetic
- edges waterproof processed
- incl. storage strip and sponge container
- rulings optional







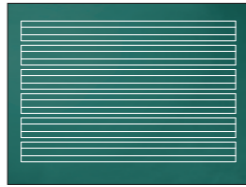
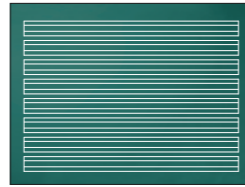

6855 SERIES

Dimensions	SHEET STEEL GREEN		SHEET STEEL WHITE	
	H 100	H 120	H 100	H 120
W 120 cm	6855 202		6855 302	
W 150 cm	6855 203	6855 204	6855 303	6855 304
W 200 cm	6855 205	6855 206	6855 305	6855 306



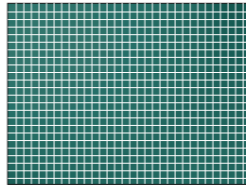
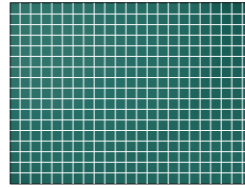
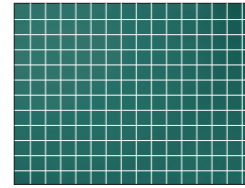
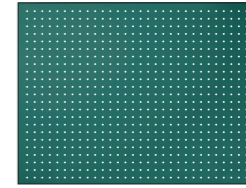
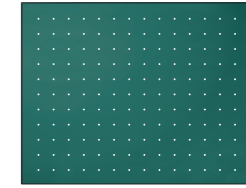

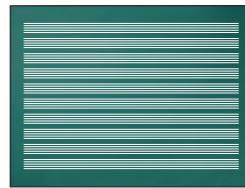



incl. storage strip and sponge container

RULINGS

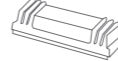
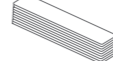
- all rulings are possible on green, enamelled writing surface as well as on frosted glass inlay wings
- selected rulings on **white enamel steel** up to board size 300 x 120 cm possible

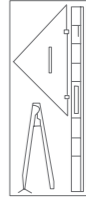
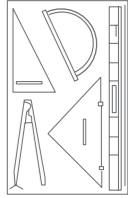
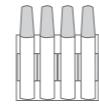
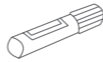
1. SCHOOL YEAR	2. SCHOOL YEAR	3. SCHOOL YEAR	4. SCHOOL YEAR	4. SCHOOL YEAR
				
RULING 01 Distance: 4 5 4 cm	RULING 02 Distance: 3 4 3 cm	RULING 03 Distance: 3.5 8 cm	RULING 04 Distance: 10 cm also on steel enamel white	RULING 08 Distance: 8 cm
CALCULATION BOX	CALCULATION BOX	CALCULATION BOX	CROSS CHECK	CROSS CHECK
				
RULING 05 Distance: 5 cm also on steel enamel white	RULING 07* Distance: 7 cm	RULING 10 Distance: 10 cm also on steel enamel white	RULING 11 Distance: 5 cm also on steel enamel white	RULING 12 Distance: 10 cm also on steel enamel white
SHORTHAND LINES	NOTE LINES	NOTE LINES	*Ruling 07 not available with white frosted glass inlay board	
				
RULING 14 Distance: 4 cm	RULING 15 Distance: 2.5 cm also on steel enamel white	RULING 16 Distance: 5 cm		

ACCESSORIES

PICTURE CLAMPING STRIP	PICTURE CLAMP	BOARD WIPER	WIPING FELTS	DRAWING SETS		
						
6865	6860	509261	509296	6862 4-piece: ruler, compass, set-square 60 cm, pointer, instrument board, magnetic	6863 4-piece: ruler, compass, set-square 80 cm, pointer, instrument board, magnetic	6869 6-piece: ruler, compass, angle 45°, angle 30°, protractor, pointer, instrument board, magnetic
BOARD PEN HOLDER	BOARD PEN	PIN SET	HOLDING MAGNETS	POWER MAGNETS		
						
509303	509304	509260	509306	509307		

PRODUCTS AND MATERIALS

Every day poses new challenges in terms of functionality and durability of furniture in the educational field. For more than 80 years, we have been working on ideas for high-quality educational furniture which will brighten your day for a long time. We have developed new materials, innovative production methods, and intelligent detailed solutions which have made learning and teaching more comfortable and safer.

And with all due humility - we are quite proud of this. We will present an overview of a part of our selection on the following pages.





A2S FINISH BOARDS

When pupils are letting off steam, the tables at which they sit should be particularly resistant to abrasion, scratches and shocks. That's exactly why we have covered all our tabletops, which are made of chipboard with A2S standard finishes, in several layers with a robust melamine resin coating.

This means that school furniture not only survives the rough everyday school life, it is also easy to clean and largely glare-free.



WOODMARK

Our tabletops are subjected to a lot of wear and tear every day. That's why we provide them with a lot for their journey through life. Special resins ensure break-proof quality of our MDF carrier boards. Under high pressure and heat we press the upper and lower cover layer of hard-wearing, melamine resin-coated finish layer with the board in a metal mould. This makes Woodmark surfaces particularly resistant to abrasion, scratches and impacts.

They are glare-free and easy to clean. Rounded edges reduce the risk of injury.



COMPACT BOARD

The compact board is a highly compressed, black colored wood fibre board. The natural material wood is gently defibered during production and further processed according to ecological aspects. The board has a very high density and is therefore, despite its slim design (thickness 12 mm), extremely robust and the edges are particularly resistant.

MULTIPLEX

Multiplex is, as a material made of cross-glued solid veneers, very dimensionally stable and resilient. For our table tops we coat the robust core made of solid beech multiplex on both sides with 0.8 mm thick HPL laminate, which is abrasion-, scratch- and impact-resistant. In addition it is fire-retardant, food-safe and environmentally friendly, thanks to renewable raw materials. Soft rounded edges make the table tops less susceptible to possible damage and reduce the risk of injury.





PLASTIC EDGE

The plastic edge is robust and shock-proof. As standard, these plastic edges are manufactured in a color matching the surface finish. These edges are ideally suited for table tops in administrative areas.

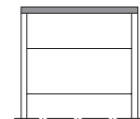

1 mm square edge
(corpus furniture)



3 mm edge rounded off
(front panels of corpus furniture and table tops)

SOLID WOOD EDGES

A2S solid wood edges are firmly glued to the chipboard, have a high-quality appearance and protect the stressed furniture edges. We offer our concealed edges for the highest demands - in this case the chipboard is additionally coated on both sides with a 0.8 mm thick HPL board. This abrasion-, scratch-resistant and shock-proof HPL coating is fire-retardant, food-safe and, thanks to renewable raw materials, environmentally friendly.



Concealed edge
band crowned



ASSODUR® EDGE

For the ASSODUR® edge, the elastic and liquid polyurethane edge is cast onto the table edge in a metal mould. Due to the strong cross-linking with the board material, it is thus particularly permanently bonded to the chipboard. The ASSODUR® edges are available in three color combinations, all free of PVC and especially abrasion- and impact-resistant.

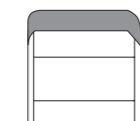

PAGHOLZ®

PAGHOLZ®

Wherever furniture is subject to particularly heavy use, we rely on PAGHOLZ®, an invention from our company. For PAGHOLZ®, thin veneer layers are prepared at great expense, individually stained and soaked in synthetic resin. Only then we press them under heat with up to 2,000 tons of pressure into the desired shape.

PAGHOLZ® offers the natural appearance of solid wood and much more:

- high form stability
- high scratch and wear resistance
- shock and break resistance
- resistance to staining and abrasion
- light fastness and resistance to chemicals

For you, this means: easy cleaning and flame-resistant, self-extinguishing material that is even weatherproof with special resins on request.

You can be sure of that: We only use native red beech from tree stocks that are carefully reforested. And of course all products made of PAGHOLZ® are particularly durable and can be recycled.



Resistant to
chemicals



Stain- and
abrasion-resistant



Hardly inflammable,
self-extinguishing



Scratch- and
wear-resistant



Shock- and
break-proof



Lightfast

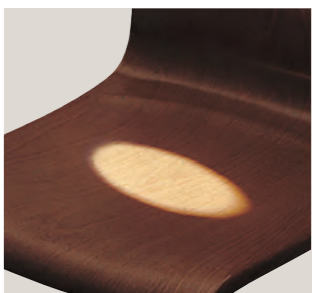

FINISH

PRICE GROUP 1



PRICE GROUP 2

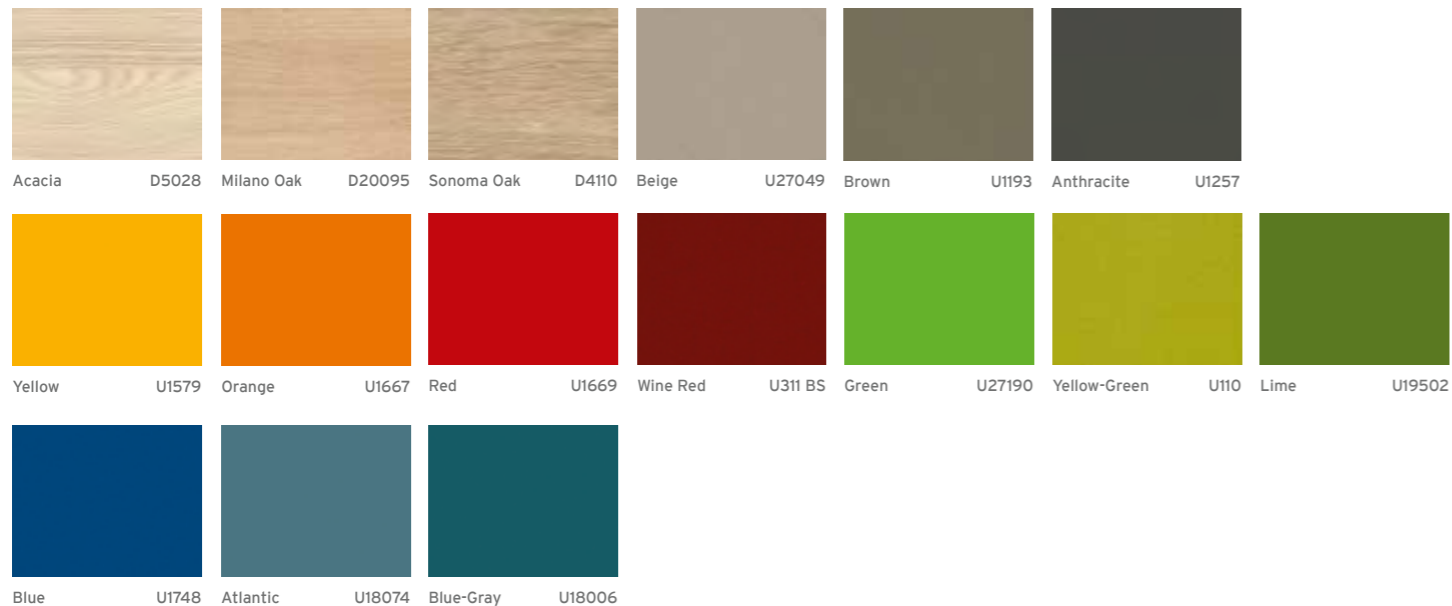

ASSODUR®-EDGE COMBINATIONS

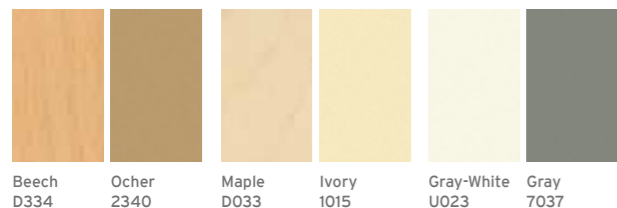

WOODMARK FINISH

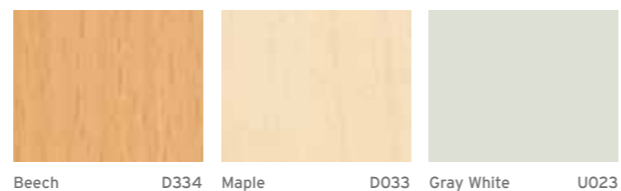

PAGHOLZ® COLOUR WOOD

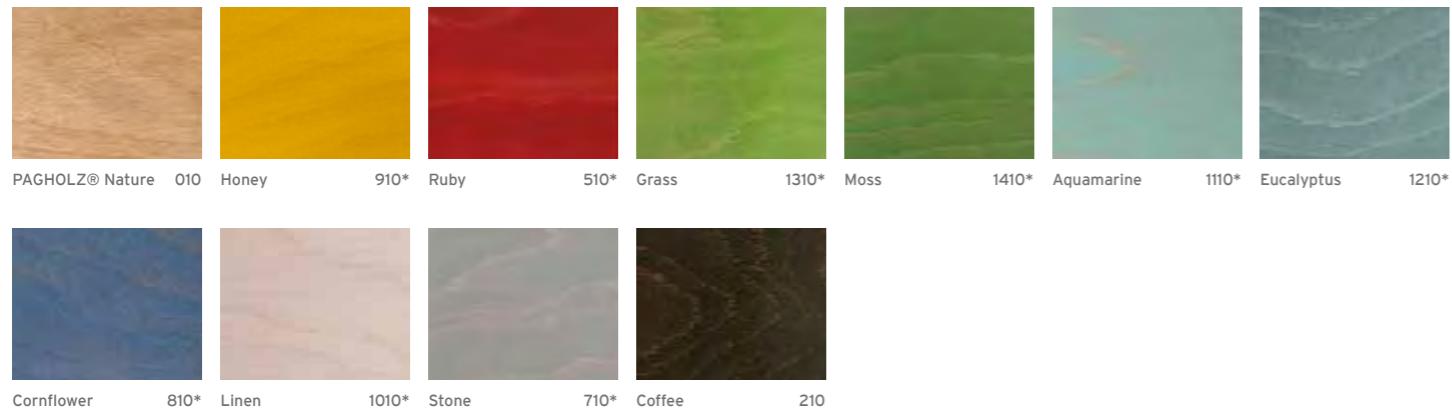

* WOODMARK COLOUR WOOD

MULTIPLEX COLOUR WOOD VENEER LONGITUDINAL



CPL LAMINATE MULTIPLEX TRANSVERSELY VENEERED CHAIRS

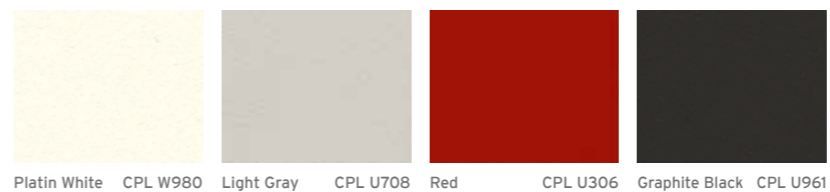

STEEL COLOURS

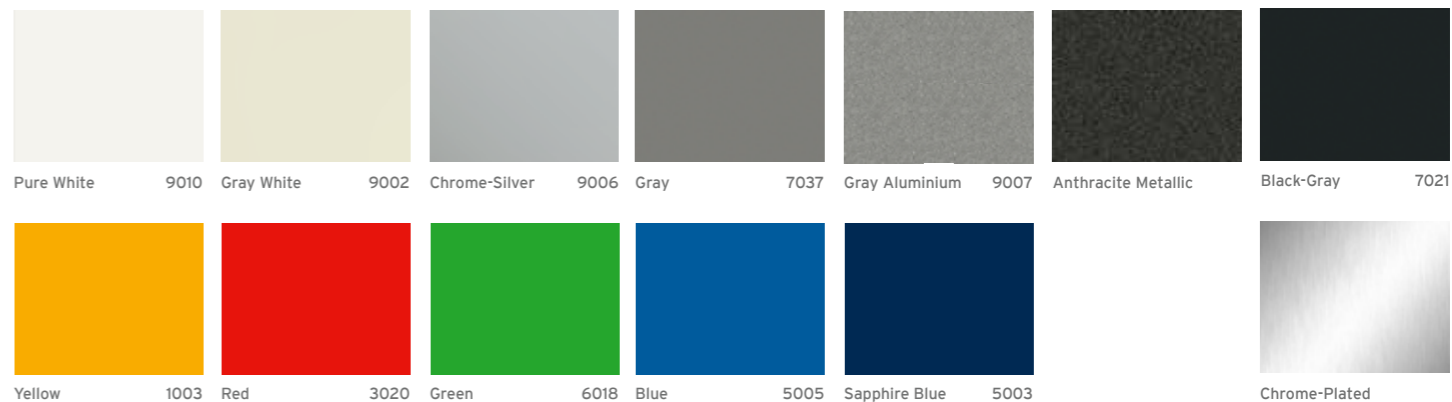

PLASTIC COLORS FLEX

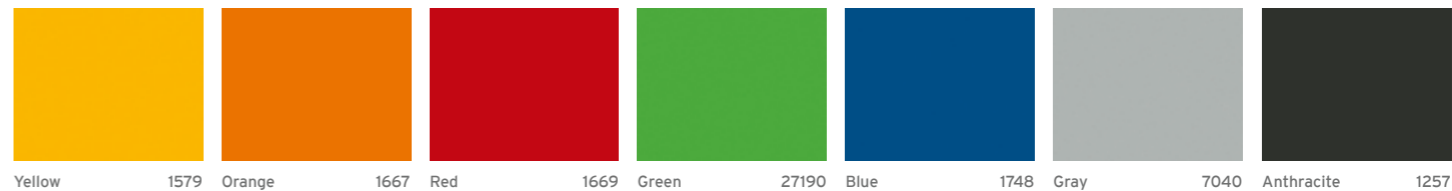

PLASTIC COLORS TIDY BOX



CORK



Natural Cork

CORK-LINOLEUM

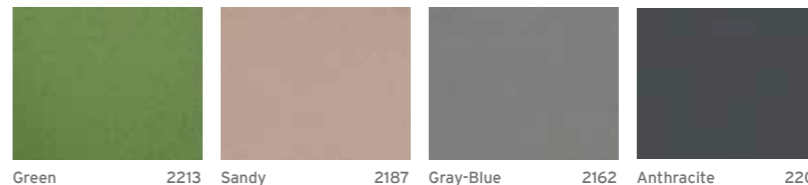

Green 2213, Sandy 2187, Gray-Blue 2162, Anthracite 2204

FABRICS for all, full upholstery, upholstered furniture

PRICE GROUP 1

INTENSIVE



Yellow BD 005 Orange BD 012 Terra BD 013 Red BD 011 Light Green BD 021 Green BD 048



Dusty Blue BD 003 Jeans Blue BD 071 Dark Blue BD 006 Aubergine BD 004 Light Brown BD 008 Dark Brown BD 036



Light Gray BD 078 Anthracite BD 023 Black BD 033

SKANDIA



Gray-Beige Blend SN 084 Old Rose Blend SN 061 Aubergine Blend SN 069 Light Green Blend SN 031 Khaki Blend SN 034 Gray-Blue Blend SN 072 Dark Blue Blend SN 080

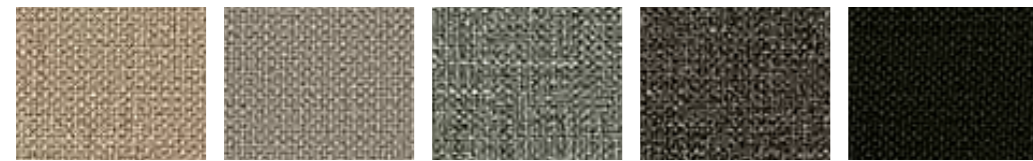

Sand Blend SN 017 Taupe Blend SN 011 Gray Blend SN 021 Anthracite Blend SN 005 Black SN 014

FLEECE



Terra FN 019 Wine Red FN 020 Light Green FN 018 Dark Green FN 017 Mint FN 016 Blue-Gray FN 015 Petrol FN 014



Dark Blue FN 013 Nature Blend FN 002 Gray-Green Blend FN 001 Light Gray Blend FN 005 Dark Gray Blend FN 004

PRICE GROUP 2

TAFF B1



Yellow PA 390 Mustard Yellow PA 352 Yellow-Orange Blend PA 930 Light Red PA 527 Red PA 010 Dark Red Blend PA 511 Aubergine PA 020



Lime PA 060 Lime Blend PA 560 Green PA 065 Green Blend PA 565 Dark Green PA 736



Petrol PA 653 Light Blue PA 050 Blue-Gray Blend PA 550 Blue PA 040 Dark Blue Blend PA 541 Ivory PA 030 Beige PA 153



Gray-Brown Blend PA 532 Light Gray PA 854 Gray PA 814 Gray Blend PA 555 Gray-Orange Blend PA 531

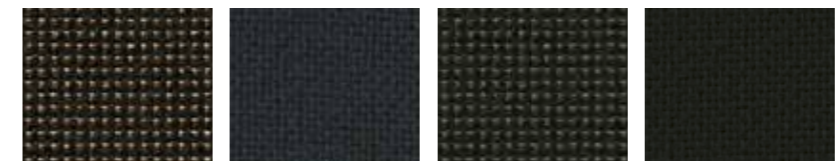

Black-Brown Blend PA 533 Anthracite PA 810 Anthracite Blend PA 571 Black Uni PA 833

PRICE GROUP 3

PROTEX



Pure White SV 280 Yellow SV 065 Orange SV 662 Terra SV 661 Red SV 211 Purple SV 214 Aubergine SV 064



Light Green SV 508 Medium Green SV 010 Dark Green SV 563 Turquoise SV 031 Ice Blue SV 213 Medium Blue SV 067 Dark Blue SV 307



Beige SV 001 Light Brown SV 009 Dark Brown SV 424 Light Gray SV 401 Dark Gray SV 402 Anthracite SV 902 Black SV 901

The materials presented in this brochure have been reproduced as faithfully as possible. Color deviations are possible and therefore the original samples should be used as a basis for decision when ordering. Just contact us with your inquiry for real material samples.

PRICE GROUP 3

WOOL

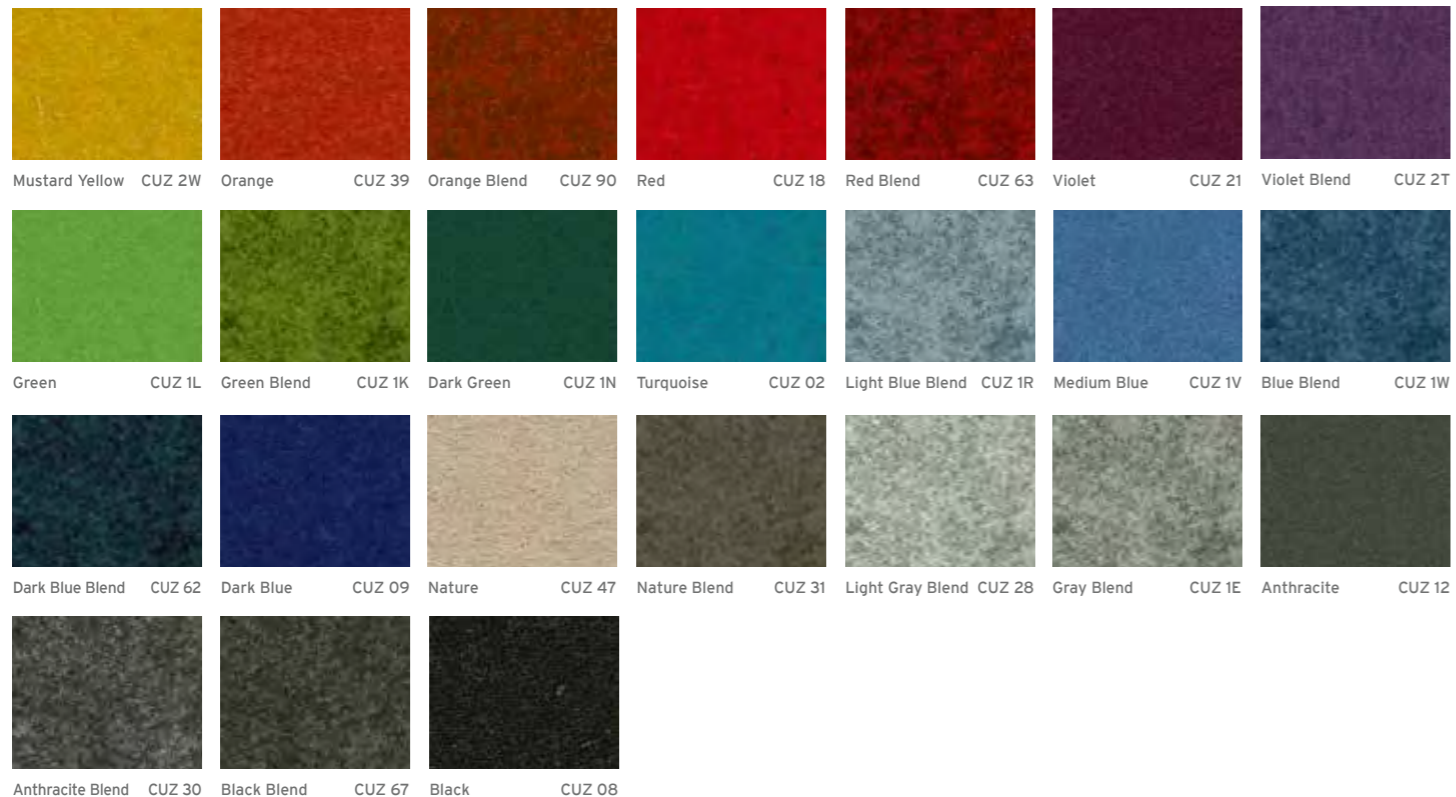

ARTIFICIAL LEATHER



PRICE GROUP 4

ARTIFICIAL LEATHER B1



PRODUCT-RELATED FABRICS

BEANBAG RANGE CHILL

OX

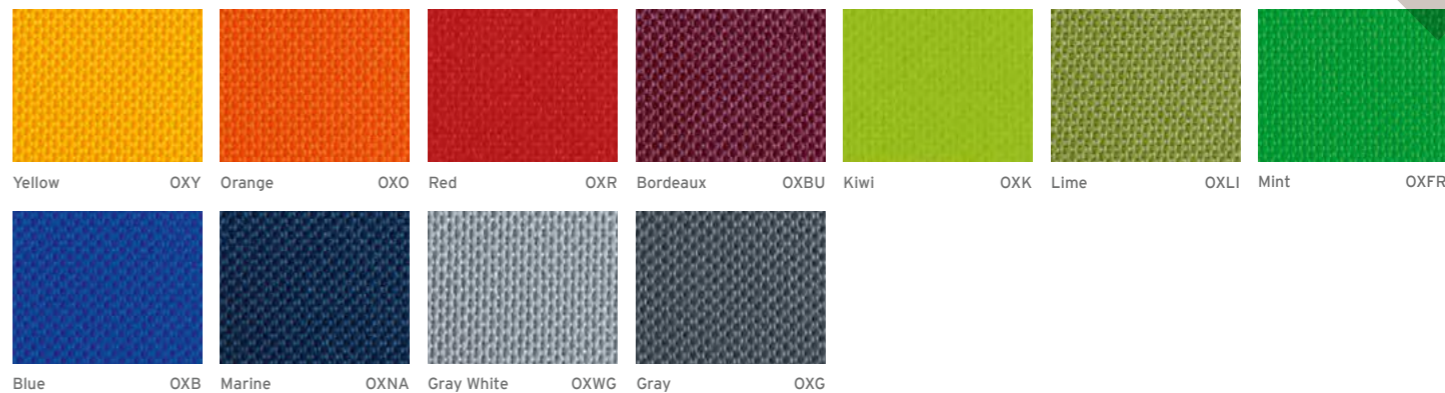

NORDIC

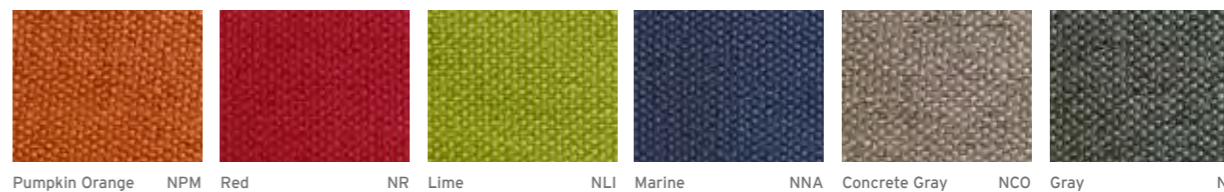

OUTSIDE



UPHOLSTERY FABRIC | UPHOLSTERY LEATHER

FLEX | WAVE

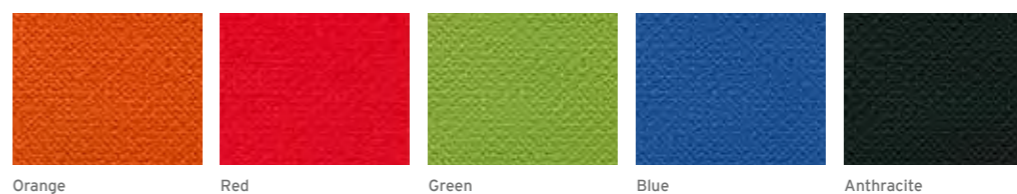

WAVE LEATHER



LEAF-SHAPED ACOUSTIC ELEMENTS

FILZ

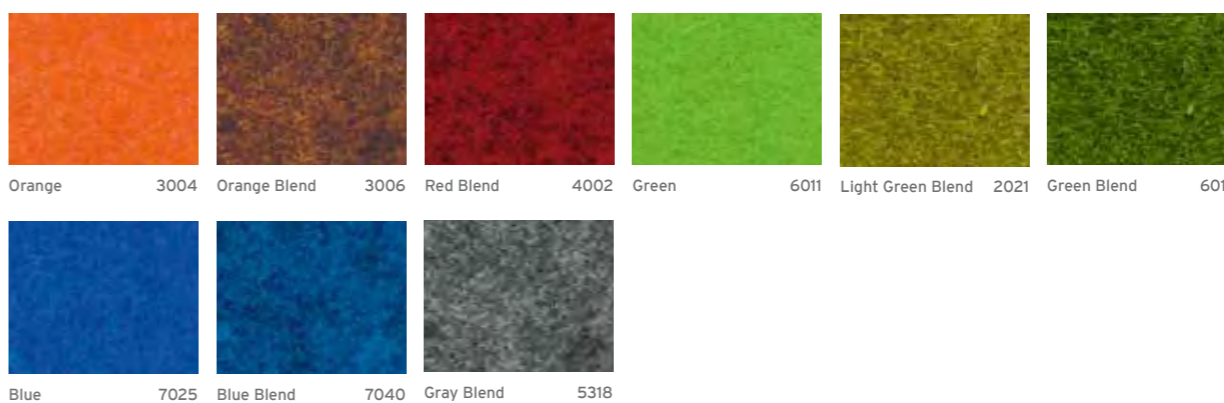

YOUR LOCAL DISTRIBUTOR



JONATHAN MORGAN & COMPANY LIMITED

1.888.856.7800

www.monarquefurniture.com

info@monarquefurniture.com

1.86m.ona.rque

1.866.662.7783

FABRIC CHARACTERISTICS

INTENSIVE	100% polyester flame retardant according to EN 1021 1&2 weight 250 g/m ² +/-5% abrasion resistance in Martindale > 100,000 runs pilling 5 tested for harmful substances ÖKO-Tex 100
SKANDIA	100% polyester flame retardant according to EN 1021 1 weight 245 g/m ² +/-5% abrasion resistance in Martindale 70,000 runs pilling 4-5 tested for harmful substances ÖKO-Tex 100
FLEECE	100% polyester flame retardant BS 5852:Part1:1979 (cigarette) weight 402 g/m ² abrasion resistance in Martindale 100,000 runs pilling 4 tested for harmful substances ÖKO-Tex 100
TAFF B1	100% polyester flame retardant according to EN 1021 1&2, DIN 4102 B1 weight 260g/m ² +/-5% abrasion resistance in Martindale 70,000 runs pilling 5 tested for harmful substances ÖKO-Tex 100
PROTEX	Surface 100% vinyl, fabric 100% polyester flame retardant according to EN 1021 1&2, DIN 4102 B2 weight 685 g/m ² abrasion resistance in Martindale 300,000 runs no pilling tested for harmful substances wipeable with soap and water water-repellent antibacterial antistatic stain protection resistant to blood and urine mould-resistant carrier layer and surface disinfectant-proof
WOOL	100% wool flame retardant according to EN 1021 1&2 weight 460 g/m ² +/-5% abrasion resistance in Martindale 50,000 runs pilling 4 tested for harmful substances
ARTIFICIAL LEATHER	Surface 100% polyurethane/ fabric 65% polyester, 35% cotton flame retardant according to EN 1021 1-1 weight 435g/m ² +/-10% abrasion resistance in Martindale > 100,000 runs no pilling tested for harmful substances
ARTIFICIAL LEATHER B1	85% PVC compound, 15% BW knitted fabric flame retardant according to EN 1021 1&2, DIN 4102 B1 weight 780+/-50 g/m ² abrasion resistance in Martindale > 75,000 runs no pilling tested for harmful substances resistant to blood and urine disinfectant-proof
FLEX/WAVE	Flame retardant according to DIN 4102 B1 weight 250 g/m ² +/-5% abrasion resistance in Martindale 40,000 runs pilling 4 tested for harmful substances ÖKO-Tex 100
WAVE LEDER	Genuine leather flame retardant according to EN 1021 1&2
OX	100% polyester with PVC coating weight 374 g/m ² abrasion resistance in Martindale 60,000 runs no pilling coating washable at 40°C wipeable waterproof
NORDIC	100% polyester weight 330 g/m ² abrasion resistance in Martindale 100,000 runs pilling 4-5 tested for harmful substances ÖKO-Tex 100 washable at 60°C
OUTSIDE	Artificial leather 83% PVC, 15% PES, 2% PU flame retardant according to EN 1021 1&2 weight 600 g/m ² abrasion resistance in Martindale 120,000 runs no pilling tested for harmful substances wipeable waterproof
FILZ	Colour 5318 - 100% polyester other colours 100% polypropylene flame retardant according to EN 1021 1&2 weight 300 g/m ² +/- 10%



WWW.MONARQUEFURNITURE.COM

Subject to technical changes. No liability for printing errors. ASS-ST.EXPO.01.05.EN.01 Edition 1 01/2023